













Safe working with non-sparking tools 2019

*non-sparking 



SERVICE / FEATURES		2- 9
SPANNERS NON-SPARKING		10 - 33
SOCKET SETS AND ACCESSORIES NON-SPARKING		34 - 51
SCREWDRIVERS NON-SPARKING		52 - 57
PLIERS NON-SPARKING		58 - 63
HAMMERS NON-SPARKING		64 - 73
KNIVES, SCRAPERS NON-SPARKING		74 - 79
BRUSHES, SCRUBBERS NON-SPARKING		80 - 83
HATCHETS, SHOVELS, SPADES, FORKS NON-SPARKING		84 - 89
WEDGES, CROWBARS NON-SPARKING		90 - 95
OTHER HAND TOOLS NON-SPARKING		96 - 99
SPECIALITIES NON-SPARKING		100 - 103
ARTICLE INDEX - CREDITS		

 **Info**

- More non-sparking tools on request!
- Haven't you found the right tool?
- Ask us about custom-orders.
- Your problems are our assignments.



non-sparking

Why the need for non-sparking tools?

- The recommendation is to use GEDORE non-sparking tools in all areas where combustible or easily ignitable vapours, liquids and dusts are on hand and everywhere where there is a potential fire and explosion risk from sparks.

Characteristics of GEDORE non-sparking tools:

- Made either from proven, low-sparking special bronze and copper/beryllium alloys or from other non-spark inducing materials (e.g. wood or electrically conducting plastics)
- The spanners are cast and not forged for your own safety.
- Corrosion-resistant - even against salt water.
- Copper/beryllium tools are anti-magnetic!

Why the need for the casting process ?

- In contrast to the usual steel tools, the forging process is not the optimum manufacturing one as far as non-sparking tools are concerned. Whilst forged, non-sparking tools may have an elegant appearance, their drawback is one of suddenly breaking in instances of overloading.
- Casting these materials, in contrast, results in them bending rather than breaking when subject to overloading.
- As cast, non-sparking spanners are of a stronger material cross-section, they ensure uniform transfer of torque forces.
- We guarantee that GEDORE non-sparking spanners are manufactured from a pure melt without the addition of scrap.
- Advantages: Improved elasticity, reduced brittleness and uniform material properties





Info

- The harder a material, the greater the risk of sparks developing and explosions occurring.
- As only a cold spark, if at all, develops, the iron share in special bronze is not of a critical nature.
- The use of non-sparking tools is a step:
 - to avoid explosions
 - to avoid incipient fires
 - to avoid and keep away sources of ignition (sparks forming) which might arise when hand tools are in use (e.g. hammer and chisel)
- The talk usually is of „non-sparking“ or „anti-spark“ tools.
- From the physics angle, it would be more accurate to refer to „low-spark“ since ignitable sparks cannot be 100 % prevented even when these tools are used.

Notes on use

CAUTION!

- As in applications non-sparking tools are not as hard as conventional ones, they must be used with particular care.
- Any over-loading is to be avoided.
- Using non-sparking tools must not be the only protective step taken in areas at risk from fire and explosions.
- For a comprehensive protection of both people and facilities, do follow the relevant safety guidelines of the various institutions, e.g. those of the industry associations, employers' instructions as well as the statutory specifications of the country in question.

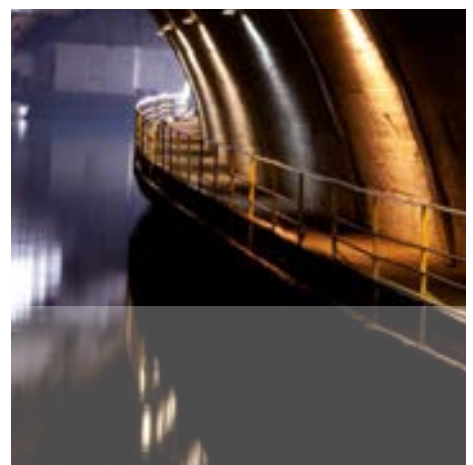
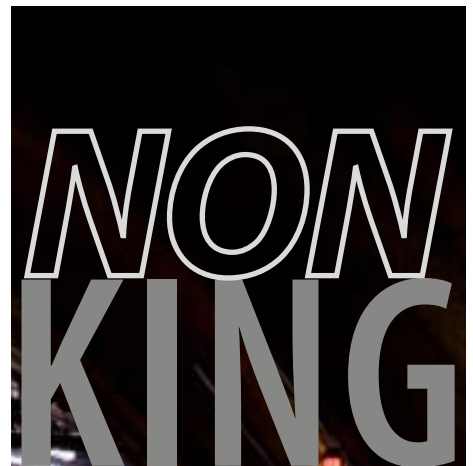

funkensfrei

NON SPARKING

GEDORE safety tools Reworking

- ▶ The alloy from which the tool is made needs to be clearly established at the outset before GEDORE safety tools can be effectively and properly reworked.
- ▶ Tools made of special bronze have a yellow colour (the surface colour may vary from the effects of atmosphere, chemicals and heating) whilst those of copper/beryllium display a red tone and are usually stamped with the alloying name e.g. "CuBe".
- ▶ Tools made from GEDORE non-ferrous metal can be reworked through forging, regenerating welding and machining.
- ▶ This reworking should preferably be carried out in our plant as following work relating to the "a" and "b" items below a hardness test - if not even tool hardening itself - must take place.
 - a) Forging is done at temperatures between 785 °C and 900 °C; the most favourable forging temperature is around 880 °C. Temperature limits are to be precisely followed. As for the rest, no special arrangements need to be made. Even so, the parts must not be cooled by quenching but, instead, left to slowly cool in the air.
 - b) Welding filler metals - which are the same as the materials - are used for welding build-up and repair welding work.
 - c) Even with reworking involving cutting, no special precautionary steps need to be kept to. The same processing tools and devices as for the steel hand tools can be used. Effective forms of cooling (e.g. water) are to be on hand for any re-grinding work.
- ▶ Considerable precision and care is required when reworking CuBe tools. In particular, it is to be borne in mind that copper/beryllium dust or vapour is toxic and can damage one's health. Moreover, copper can very easily lose its alloying properties - if not in their entirety under certain conditions - from over-heating. The result then is that the material only displays the properties of ordinary copper.
 - a) Our recommendation is not to re-forged CuBe tools or parts of them - all the more so since extensive experience is needed for forging in conjunction with secondary heat treatment. Do ask us if forging in certain circumstances is implementable.
 - b) In machining and with grinding, in particular, cooling must be carefully carried out and heating to over 250 °C is to be avoided at all circumstances. If processing is undertaken in the cured state, a cutting angle of around 0 ° is needed for the processing tools.





Important information

- ✔ for regrinding GEDORE copper/beryllium safety tools:
- ✔ Beryllium is a metal which according to the Materials Ordinance is considered to be toxic !
- ✔ This very much concerns dusts and vapours which may arise where smelting, grinding and welding is undertaken.
- ✔ There is no risk, however, when grinding, in particular, is of the wet variety!
- ✔ **Should this not be possible in exceptional circumstances, then the following steps need to be noted:**
 1. Do not inhale any dust (wear a face mask)
 2. Avoid one's skin and eyes coming into contact with them
 3. Wear protective clothing
 4. Wear breathing apparatus should dust and smoke develop



nonsparking



Non-sparking material analysis

Material	Copper-Beryllium			
Analysis	Be	Ni	Co	Cu
min. in %	1,8	0,1	0,4	96,5
max. in %	2,3	0,5	0,7	97,7
Mechanical properties				
Strength N/mm ²	1117 - 1326			
Yield point N/mm ²	840 - 880			
Hardness Brinell	280/365			

Material	Special Bronze (Aluminium-multicomponent-bronze)				
Analysis	Cu	Al	Ni	Fe	Mn
min. in %	76	8	4	4	-
max. in %	84	10,5	6	5,5	1,33
Mechanical properties	cured		untreated		
Strength N/mm ²	780 - 989		600 - 670		
Yield point N/mm ²	450 - 550		250 - 270		
Hardness Brinell	230 - 290		140 - 180		

- Since special bronze would involve over rapid and excessive wear of all tools with mechanical movements, cutting functions and tip stresses (such as pliers, ratchets and adjustable spanners), they are manufactured from the harder CuBe.
- Spanners are mostly manufactured from special bronze.



Notes on use

- The softer the tool the lower the probability of sparks forming. Selection is at all times to be for that lowest tool hardness which just suffices for the work on hand. This is something that through our knowledge of tools we have already dealt for you. We use the optimum possible material for each and every tool. Tools subject to concentrated loads are manufactured from the harder CuBe.

The letter at the end of the Article No. stands for the material:

GEDXXXXXXXS = tool made of special bronze

GEDXXXXXXXC = tool made of CuBe (copper beryllium)

funk
ken



FREI

*non-sparking

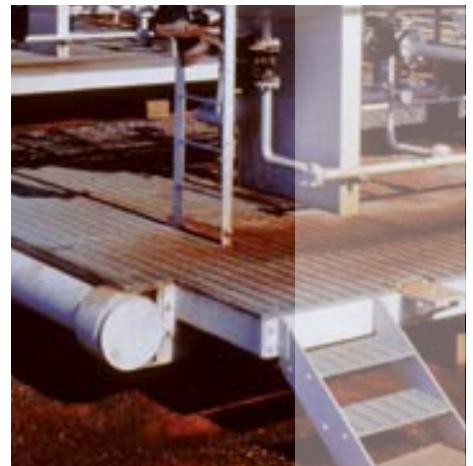

Dictionary of the EX zones

Explosion protection acc. to ATEX = Explosive atmosphere

- ▶ ATEX 137 (118) also designated as Guideline 99/2/EC covers the safety of people employed in the installation, operation and maintenance of facilities at risk from explosions.
- ▶ Since July 2003 only operating equipment in compliance with this guideline may be commercially used. The ATEX 99/92/EC specification is such that GEDORE tools may be used in the EX zones.

INFO:

- ▶ The ATEX instruction covers products falling under the CE instruction - e.g. electrical products - where a spark could arise from their use. Hand tools do not fall within the scope of the ATEX instruction. Hand tools do not fall within the scope of the ATEX product instruction. Only products for which a CE identification is prescribed fall within the scope of the ATEX instruction (e.g. lamps)
- ▶ EX zones refer to areas at risk from explosions as a function of the frequency and duration of the emergence of hazardous, explosive atmospheres.

The following zones apply to areas with the risk of explosions present from combustible gases, vapour or mists:

Zone 0

- ▶ is an area where a hazardous, explosive atmosphere as a mix of air and combustible gases, vapours and mists prevail either constantly, for lengthy periods or frequently.

Zone 1

- ▶ is an area where under normal operations a hazardous, explosive atmosphere as a mix of air and combustible gases, vapours and mists can occasionally form.

Zone 2

- ▶ is an area where under normal operations a hazardous, explosive atmosphere as a mix of air and combustible gases, vapours and mists usually does not arise or, if it does, then only briefly.

The following zones apply to areas at risk from explosions occasioned by combustible dusts:

Zone 20

- ▶ is an area where hazardous, explosive atmospheres in the form of a cloud made up of combustible dusts from the air prevail either constantly, for lengthy periods or frequently.

Zone 21

- ▶ is an area where under normal operations a hazardous, explosive atmosphere in the form of a cloud made up of combustible dusts from the air can occasionally form.

Zone 22

- ▶ is an area where under normal operations a hazardous, explosive atmosphere in the form of a cloud made up of combustible dust from the air usually does not arise or, if it does, then only briefly.

Remarks:

- ▶ The "frequency" label is to be used in the sense of "being predominant over time".
- ▶ Normal operation describes the condition whereby facilities can be used within their design parameters.
- ▶ Many experts look upon the "for a short time" term to mean a maximum of 30 minutes.
- ▶ Consideration is to be given to layers, deposits and accumulations of combustible dust which - as with any other cause - may lead to the formation of a hazardous, explosive atmosphere.
- ▶ These definitions as to zones apply equally in all the EC member states on the basis of Guideline 1999/92/EC

Source - BG RCI (Raw materials and chemical industry)

SPANNERS



NON
SPARKING

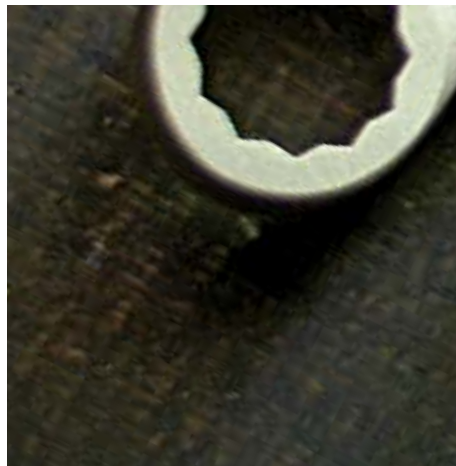
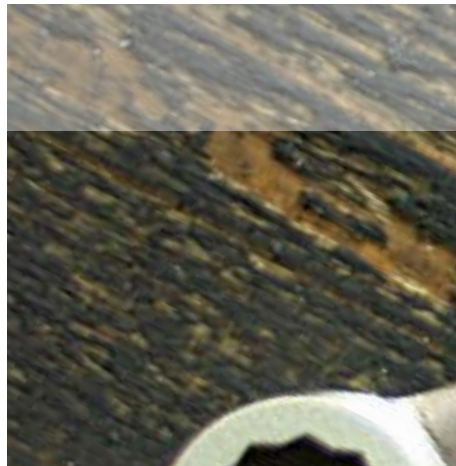

SPANNERS NON-SPARKING



SPANNERS NON-SPARKING

OPEN ENDED SPANNER NON-SPARKING

GED001

DOUBLE OPEN ENDED SPANNER

- Similar to DIN 3110
- Slim pattern, oval shaft

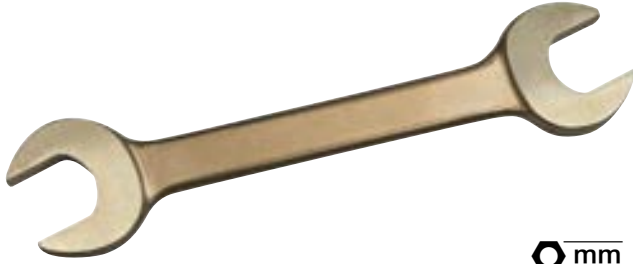

Code	No.	O mm	l mm	W mm
2502550	GED0010607S	6 x 7	125	65
2502542	GED0010608S	6 x 8	125	65
2502534	GED0010708S	7 x 8	125	65
2502526	GED0010709S	7 x 9	125	65
2502518	GED0010809S	8 x 9	125	65
2498529	GED0010810S	8 x 10	125	60
2498510	GED0010910S	9 x 10	125	60
2498502	GED0010911S	9 x 11	140	90
2495317	GED0011011S	10 x 11	140	90
2495309	GED0011012S	10 x 12	140	85
2495295	GED0011013S	10 x 13	140	80
2495287	GED0011014S	10 x 14	160	180
2495279	GED0011113S	11 x 13	160	180
2495244	GED0011114S	11 x 14	160	180
2495236	GED0011213S	12 x 13	160	180
2495228	GED0011214S	12 x 14	160	170
2495201	GED0011315S	13 x 15	160	170
2495198	GED0011415S	14 x 15	200	165
2495171	GED0011416S	14 x 16	200	220
2495163	GED0011417S	14 x 17	200	220
2495155	GED0011617S	16 x 17	200	210
2495147	GED0011618S	16 x 18	200	210
2495139	GED0011719S	17 x 19	225	350
2495112	GED0011722S	17 x 22	225	320
2495104	GED0011819S	18 x 19	225	320
2495090	GED0011820S	18 x 20	225	310
2495082	GED0011821S	18 x 21	225	300
2495074	GED0011922S	19 x 22	240	440
2495066	GED0011924S	19 x 24	240	420
2495058	GED0012022S	20 x 22	240	440
2495031	GED0012123S	21 x 23	240	420
2495023	GED0012224S	22 x 24	240	420
2495015	GED0012227S	22 x 27	270	730
2494981	GED0012326S	23 x 26	270	730
2494973	GED0012426S	24 x 26	270	730
2494965	GED0012427S	24 x 27	270	730
2494957	GED0012430S	24 x 30	270	700
2494949	GED0012528S	25 x 28	270	700
2494930	GED0012629S	26 x 29	270	700
2494922	GED0012729S	27 x 29	300	810
2494914	GED0012730S	27 x 30	300	800
2494906	GED0012732S	27 x 32	300	800
2494892	GED0013032S	30 x 32	300	780
2494876	GED0013034S	30 x 34	320	1240
2494868	GED0013036S	30 x 36	320	1220
2494841	GED0013234S	32 x 34	320	1200
2494833	GED0013236S	32 x 36	320	1140
2494825	GED0013436S	34 x 36	320	1100
2494817	GED0013538S	35 x 38	370	1480

Code	No.	O mm	l mm	W mm
2494809	GED0013641S	36 x 41	370	1480
2494795	GED0014146S	41 x 46	370	1450
2494787	GED0014650S	46 x 50	390	1400
2494779	GED0015055S	50 x 55	440	1700
2494752	GED0015060S	50 x 60	440	1700
2494744	GED0015560S	55 x 60	470	1800
2494736	GED0016065S	60 x 65	470	1800
2494728	GED0016570S	65 x 70	630	3500
2494701	GED0017080S	70 x 80	630	3400
2494523	GED0017580S	75 x 80	630	3300

GED0010

DOUBLE OPEN ENDED SPANNER SET, 12 PIECES

- Similar to DIN 3110
- Slim pattern, oval shaft
- Sets of the most used sizes



Code	No.	Contents	W mm
2516667	GED0010000S	6x7 8x9 10x11 12x13 14x15 16x17 18x19 20x22 21x23 24x27 25x28 30x32	3500





GED0017

DOUBLE OPEN ENDED SPANNER INCH

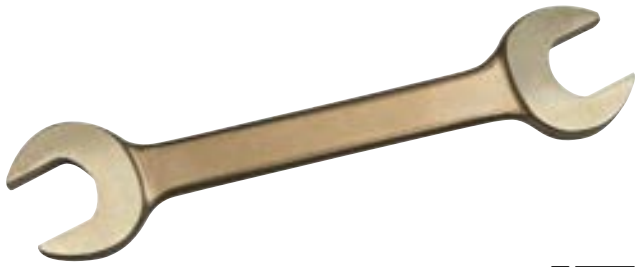
- Similar to DIN 3110
- Slim pattern, oval shaft



 "AF

Code	No.	 "AF	(mm)	
2516586	GED0017140S	7/32 x 1/4	125	65
2516659	GED0017101S	1/4 x 5/16	125	65
2498499	GED0017102S	5/16 x 3/8	125	60
2516640	GED0017103S	3/8 x 7/16	140	90
2516632	GED0017104S	7/16 x 1/2	140	85
2521326	GED0017113S	1/2 x 5/8	160	170
2516616	GED0017105S	1/2 x 9/16	160	170
2498464	GED0017114S	1/2 x 11/16	200	220
2498480	GED0017106S	9/16 x 5/8	200	220
2498456	GED0017115S	9/16 x 3/4	200	220
2494698	GED0017107S	19/32 x 11/16	200	220
2494671	GED0017116S	19/32 x 25/32	200	220
2498472	GED0017108S	5/8 x 11/16	200	200
2521369	GED0017109S	5/8 x 3/4	225	310
2521318	GED0017117S	11/16 x 25/32	225	300
2498448	GED0017118S	11/16 x 7/8	225	300
2521350	GED0017110S	3/4 x 7/8	225	300
2498421	GED0017119S	3/4 x 25/32	225	300
2498405	GED0017120S	3/4 x 13/16	225	310
2521210	GED0017141S	3/4 x 7/8	225	310
2494663	GED0017121S	25/32 x 13/16	225	300
2498391	GED0017122S	25/32 x 7/8	225	300
2498383	GED0017123S	13/16 x 7/8	225	300
2498375	GED0017124S	7/8 x 15/16	225	300
2498367	GED0017125S	7/8 x 31/32	240	400
2498359	GED0017126S	7/8 x 1	240	400
2494655	GED0017127S	7/8 x 1.1/16	270	720
2521342	GED0017111S	15/16 x 1	270	720
2521296	GED0017128S	15/16 x 1.1/16	270	720
2521288	GED0017129S	1 x 1.1/8	270	700
2516608	GED0017130S	1 x 1.5/16	300	750
2521334	GED0017112S	1.1/16 x 1.1/4	300	750
2521261	GED0017131S	1.1/8 x 1.5/16	300	750
2516578	GED0017142S	1.1/16 x 1.7/16	320	1220
2494647	GED0017132S	1.1/8 x 1.1/2	320	1150
2494620	GED0017133S	1.1/4 x 1.3/8	320	1150
2521253	GED0017134S	1.1/4 x 1.7/16	320	1150
2521237	GED0017135S	1.5/16 x 1.1/2	370	1480
2494612	GED0017136S	1.1/4 x 1.5/8	370	1400
2494604	GED0017137S	1.3/8 x 1.1/2	370	1400
2521229	GED0017138S	1.7/16 x 1.5/8	370	1400
2516594	GED0017139S	1.1/2 x 1.11/16	370	1400
2516551	GED0017143S	1.5/8 x 14	370	1400
2494590	GED0017144S	1.5/8 x 1.3/4	370	1350
2516543	GED0017145S	1.11/16 x 1.7/8	370	1350
2498340	GED0017146S	1.11/16 x 2	390	1700
2498332	GED0017147S	1.13/16 x 2	390	1700
2521202	GED0017148S	1.3/4 x 2.1/16	390	1700
2498324	GED0017149S	2 x 2.3/16	440	1700
2498316	GED0017150S	2 x 2.5/16	440	1700
2521199	GED0017151S	2.3/16 x 2.3/8	470	1800
2494582	GED0017152S	2.1/4 x 2.3/8	470	1800

GED0010

DOUBLE OPEN ENDED SPANNER SET INCH, 8 PIECES

- Similar to DIN 3110
- Slim pattern, oval shaft
- Sets of the most used sizes



 "AF

Code	No.	Contents	
2521385	GED0010001S	1/4x5/16 3/8x7/16 7/16x1/2 1/2x9/16 9/16x5/8 5/8x11/16 3/4x7/8 15/16x1AF	1700



GED00172

DOUBLE OPEN ENDED SPANNER SMALL

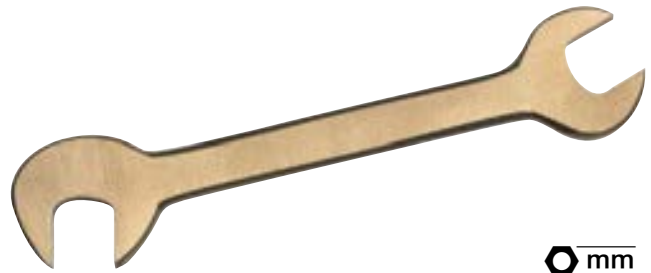
- Stamped from sheet metal
- With same size each end
- Offset head (75° and 15°) for difficult applications



 mm

Code	No.	 mm	(mm)	
2502496	GED0017204S	4	70	7
2498278	GED0017201S	4,5	70	7
2502488	GED0017205S	5	78	7
2498251	GED0017202S	5,5	78	10
2502461	GED0017206S	6	78	10
2502453	GED0017207S	7	91	10
2502445	GED0017208S	8	96	15
2502429	GED0017209S	9	103	15
2498243	GED0017210S	10	105	20
2498235	GED0017211S	11	116	20
2498227	GED0017212S	12	116	35
2498219	GED0017213S	13	131	35
2498200	GED0017214S	14	131	35

GED00172

DOUBLE OPEN ENDED SPANNER SET SMALL, 10 PIECES

- Sets of the most used sizes



 mm

Code	No.	Contents	
2516535	GED0017200S	5 5,5 6 7 8 9 10 11 12 13	180

GED00171

DOUBLE OPEN ENDED SPANNER

▀ Stamped from sheet metal



Code	No.	Ø mm	l mm	l ₁ mm
2494574	GED0017153S	3 x 3,5	50	5
2494566	GED0017154S	4 x 4,5	60	5
2494558	GED0017155S	5 x 5,5	70	6
2498294	GED0017156S	6 x 7	80	8
2498286	GED0017157S	8 x 9	90	10
2494531	GED0017158S	10 x 11	100	12

GED00171

DOUBLE OPEN ENDED SPANNER INCH

▀ Stamped from sheet metal



Code	No.	Ø AF	l mm	l ₁ mm
2493667	GED0017159S	5/32 x 3/16	60	5
2493543	GED0017160S	3/16 x 7/32	70	6
2510871	GED0017161S	1/4 x 9/32	80	8
2510766	GED0017162S	1/4 x 5/16	80	8
2518937	GED0017163S	5/16 x 11/32	90	10
2510642	GED0017164S	5/16 x 3/8	90	10
2518813	GED0017165S	5/16 x 13/32	100	12
2510510	GED0017166S	3/8 x 7/16	100	12

GED0020

SINGLE OPEN ENDED SPANNER

▀ Extra-long shaft for deep applications
▀ Secure grip thanks to profile shaft

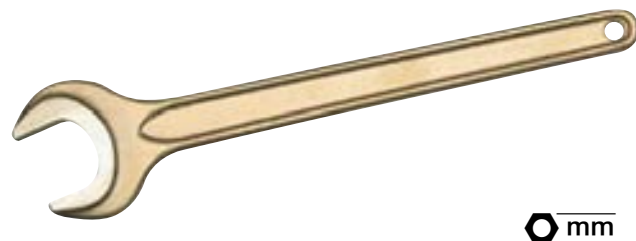

Code	No.	Ø mm	l mm	l ₁ mm
2512157	GED0020006S	6	90	14
2512149	GED0020007S	7	90	13
2512130	GED0020008S	8	90	12
2512122	GED0020009S	9	90	11
2511592	GED0020010S	10	100	25
2511584	GED0020011S	11	100	22
2511576	GED0020012S	12	140	45
2511568	GED0020013S	13	140	40
2511541	GED0020014S	14	165	80

Code	No.	Ø mm	l mm	l ₁ mm
2511533	GED0020015S	15	145	75
2511525	GED0020016S	16	165	70
2511517	GED0020017S	17	165	70
2511495	GED0020018S	18	165	70
2511487	GED0020019S	19	190	100
2511479	GED0020020S	20	190	95
2511460	GED0020021S	21	205	140
2511452	GED0020022S	22	205	130
2511444	GED0020023S	23	220	170
2511436	GED0020024S	24	220	170
2511428	GED0020025S	25	220	160
2511401	GED0020026S	26	220	160
2511398	GED0020027S	27	220	150
2511363	GED0020028S	28	250	270
2511355	GED0020029S	29	250	260
2511347	GED0020030S	30	250	250
2511339	GED0020032S	32	285	340
2511320	GED0020033S	33	285	340
2511312	GED0020034S	34	285	320
2511304	GED0020035S	35	285	320
2511290	GED0020036S	36	285	300
2511282	GED0020037S	37	285	300
2511274	GED0020038S	38	330	540
2511258	GED0020041S	41	330	520
2511231	GED0020042S	42	330	500
2511223	GED0020046S	46	360	650
2511215	GED0020047S	47	360	630
2511207	GED0020050S	50	440	1100
2511193	GED0020052S	52	440	1100
2511185	GED0020054S	54	440	1050
2511177	GED0020055S	55	440	1050
2511169	GED0020056S	56	440	1000
2511150	GED0020058S	58	480	1475
2511126	GED0020060S	60	480	1475
2511118	GED0020063S	63	520	1700
2511096	GED0020065S	65	520	1700
2511088	GED0020067S	67	520	1700
2511061	GED0020070S	70	540	1900
2511053	GED0020071S	71	540	1900
2511045	GED0020075S	75	540	1800
2511037	GED0020077S	77	540	1800
2511029	GED0020080S	80	630	2900
2511010	GED0020082S	82	630	2800
2510995	GED0020085S	85	680	3400
2510987	GED0020088S	88	680	3300
2510979	GED0020090S	90	680	3200
2510960	GED0020094S	94	830	5000
2510952	GED0020095S	95	830	4800
2509377	GED0020100S	100	800	5900
2509369	GED0020105S	105	850	8900
2509350	GED0020110S	110	900	9000
2509342	GED0020115S	115	950	9300
2509334	GED0020120S	120	990	9600
2509326	GED0020125S	125	1000	8300
2509318	GED0020130S	130	1000	8300
2509288	GED0020135S	135	1000	8300



GED0021

SINGLE OPEN ENDED SPANNER INCH

- ▶ Extra-long shaft for deep applications
- ▶ Secure grip thanks to profile shaft



 "AF"

Code	No.	Ø "AF"	l-mm	l-in
2510944	GED00210015	1/4	90	14
2510936	GED00210025	5/16	90	12
2507374	GED00210035	11/32	90	11
2510928	GED00210045	3/8	90	11
2507366	GED00210055	13/32	100	25
2509261	GED00210065	7/16	100	22
2510901	GED00210075	1/2	140	40
2509253	GED00210085	9/16	165	80
2507358	GED00210095	19/32	165	75
2510898	GED00210105	5/8	165	70
2507323	GED00210115	11/16	165	70
2509245	GED00210125	3/4	190	100
2507315	GED00210135	25/32	190	95
2507307	GED00210145	13/16	205	140
2510863	GED00210155	7/8	205	130
2507293	GED00210165	15/16	220	170
2507285	GED00210175	31/32	220	170
2513064	GED00210185	1	220	160
2505444	GED00210195	1.1/16	220	150
2507277	GED00210205	1.1/8	250	270
2505436	GED00210215	1.3/16	250	250
2507269	GED00210225	1.1/4	285	340
2505428	GED00210235	1.5/16	285	340
2507250	GED00210245	1.3/8	285	320
2505401	GED00210255	1.7/16	285	300
2507242	GED00210265	1.1/2	330	540
2505371	GED00210275	1.9/16	330	520
2507234	GED00210285	1.5/8	330	520
2502402	GED00210295	1.11/16	330	500
2507218	GED00210305	1.3/4	360	650
2502399	GED00210315	1.13/16	360	650
2507196	GED00210325	1.7/8	360	630
2513056	GED00210335	2	440	1100
2505363	GED00210345	2.1/16	440	1100
2507188	GED00210355	2.1/8	440	1050
2505355	GED00210365	2.3/16	440	1050
2507161	GED00210375	2.1/4	480	1000
2505347	GED00210385	2.5/16	480	1475
2507153	GED00210395	2.3/8	480	1475
2505339	GED00210405	2.7/16	520	1700
2507145	GED00210415	2.1/2	520	1700
2505320	GED00210425	2.9/16	520	1700
2507137	GED00210435	2.5/8	520	1700
2507129	GED00210445	2.3/4	540	1900
2502380	GED00210455	2.13/16	540	1900
2502372	GED00210465	2.15/16	540	1900
2513048	GED00210475	3	540	1800
2507110	GED00210485	3.1/8	630	2900
2507102	GED00210495	3.1/4	630	2800
2507080	GED00210505	3.3/8	680	3400
2507072	GED00210515	3.1/2	680	3300
2507064	GED00210525	3.5/8	680	3200
2507056	GED00210535	3.3/4	830	5000
2507048	GED00210545	3.7/8	830	4800

COMBINATION SPANNER NON-SPARKING

GED0130

COMBINATION SPANNER

- ▶ With same size each end, ring bi-hexagon

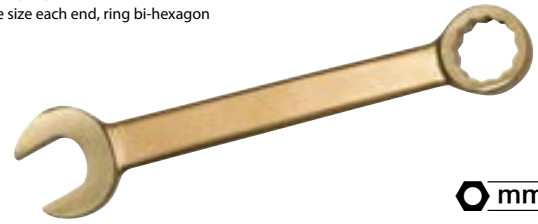

 mm

Code	No.	Ø mm	l-mm	l-in
2510855	GED01300065	6	130	50
2510847	GED01300075	7	130	55
2510839	GED01300085	8	135	55
2510820	GED01300095	9	150	95
2509148	GED01300105	103	150	85
2509121	GED01300115	11	150	90
2509113	GED01300125	12	190	170
2509105	GED01300135	13	190	165
2509091	GED01300145	14	190	160
2509083	GED01300155	15	210	230
2509075	GED01300165	16	210	230
2509067	GED01300175	17	210	220
2509040	GED01300185	18	230	330
2509032	GED01300195	19	230	330
2509024	GED01300205	20	230	325
2509016	GED01300215	21	250	360
2509008	GED01300225	22	250	355
2508990	GED01300235	23	250	350
2508982	GED01300245	24	270	500
2508974	GED01300255	25	270	475
2508966	GED01300265	26	270	470
2508958	GED01300275	27	280	665
2508923	GED01300285	28	280	680
2508915	GED01300295	29	280	630
2508907	GED01300305	30	300	730
2508893	GED01300325	32	300	650
2508885	GED01300345	34	320	950
2508877	GED01300365	36	330	930
2508869	GED01300385	38	400	2150
2508850	GED01300415	41	410	2000
2508842	GED01300465	46	410	1900
2508834	GED01300505	50	540	3400
2508818	GED01300555	55	520	3500
2508796	GED01300605	60	515	3300
2508788	GED01300655	65	500	3200
2508761	GED01300705	70	510	3800
2508753	GED01300755	75	680	3900
2508745	GED01300805	80	680	4000

GED0130

COMBINATION SPANNER SET

- ▶ Sets of the most used sizes

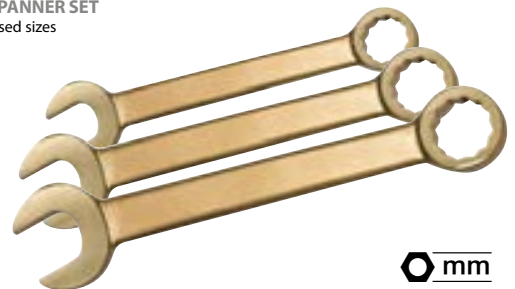

 mm

Code	No.	Contents	pieces	l-in
2497492	GED01300025	8 9 10 11 13 14 17 19	8	1200
2493551	GED01300035	8 10 11 12 13 14 16 17 18 19 22	11	2200
2493578	GED01300015	10 11 12 13 14 17 19 22 24 27 30 32	12	4100
2493586	GED01300005	6 7 8 9 10 11 12 13 14 15 16 17 18 19 20 21 22 23 24 25 26 27 28 29 30 32	26	8450

GED0137

COMBINATION SPANNER INCH

With same size each end, ring bi-hexagon

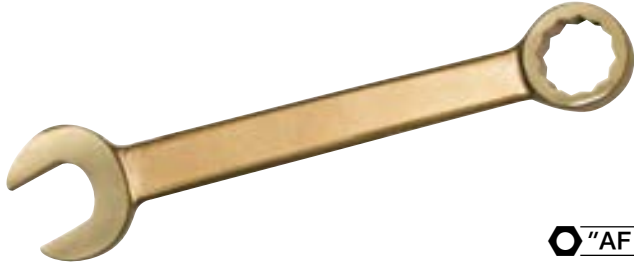

"AF

Code	No.	"AF	(mm)	
2508737	GED0137101S	1/4	135	45
2506998	GED0137102S	5/16	135	45
2504219	GED0137118S	11/32	150	60
2508729	GED0137103S	3/8	150	60
2506971	GED0137104S	7/16	150	60
2508710	GED0137105S	1/2	190	110
2506955	GED0137106S	9/16	190	110
2504286	GED0137107S	19/32	210	200
2508702	GED0137108S	5/8	210	200
2504278	GED0137109S	11/16	230	230
2508672	GED0137110S	3/4	230	230
2504200	GED0137119S	25/32	230	230
2504251	GED0137111S	13/16	250	300
2508664	GED0137112S	7/8	250	300
2504243	GED0137113S	15/16	270	410
2504197	GED0137120S	31/32	270	410
2512114	GED0137114S	1	270	410
2501139	GED0137115S	1.1/16	280	510
2504235	GED0137116S	1.1/8	280	510
2501120	GED0137121S	1.3/16	300	570
2504227	GED0137117S	1.1/4	300	570
2501112	GED0137122S	1.5/16	300	570
2504189	GED0137123S	1.3/8	330	840
2501090	GED0137124S	1.7/16	330	840
2504162	GED0137125S	1.1/2	330	840
2501082	GED0137126S	1.9/16	410	2000
2504154	GED0137127S	1.5/8	410	2000
2497484	GED0137128S	1.11/16	410	2000
2504146	GED0137129S	1.3/4	410	1900
2497476	GED0137130S	1.13/16	410	1900
2504138	GED0137131S	1.7/8	435	1600
2512092	GED0137132S	2	435	1600
2501074	GED0137133S	2.1/16	435	1600
2504111	GED0137134S	2.1/8	455	2000
2501066	GED0137135S	2.3/16	455	2000
2504103	GED0137136S	2.1/4	475	2500

GED0137

COMBINATION SPANNER, EXTRA LONG

With same size each end, ring bi-hexagon
Extra-long shaft for deep applications



mm

Code	No.	mm	(mm)	
2493527	GED0137140S	10	190	70
2493519	GED0137142S	12	210	70
2493500	GED0137143S	13	225	90
2493497	GED0137147S	17	280	135
2493489	GED0137149S	19	310	200
2493470	GED0137151S	22	350	260
2493462	GED0137153S	24	400	370
2493454	GED0137154S	27	450	500
2493446	GED0137155S	30	480	900
2493411	GED0137156S	32	500	730
2493403	GED0137159S	36	550	1200
2493381	GED0137160S	41	600	2000
2493373	GED0137161S	46	640	2800

GED0137

COMBINATION SPANNER SET, EXTRA LONG

Sets of the most used sizes

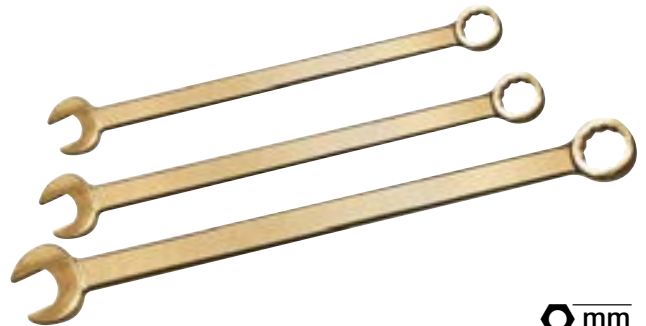

mm

Code	No.	Contents	pieces	
2493365	GED0137162S	10 12 13 17 19 22	6	825
2493357	GED0137164S	10 12 13 17 19 22 24 27 30 32	10	3325

GED0137

COMBINATION SPANNER SET INCH

Sets of the most used sizes

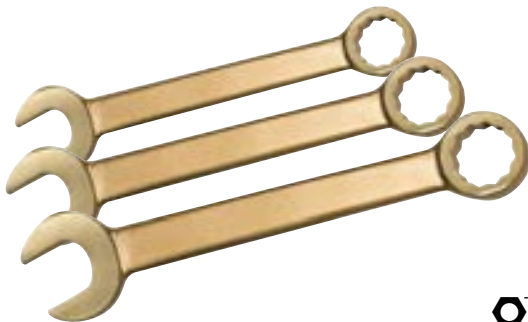

"AF

Code	No.	Contents	
2493535	GED0137100S	1/4 5/16 3/8 7/16 1/2 9/16 5/8 3/4 7/8 1 1.1/16 1.1/4	3300



GED0137

COMBINATION SPANNER OFFSET

- With same size each end
- Ring offset from shaft



 mm

Code	No.	Ø mm	l mm	l mm
2508656	GED0137170S	10	148	70
2508648	GED0137172S	12	168	65
2508621	GED0137173S	13	185	80
2508613	GED0137177S	17	232	140
2508605	GED0137179S	19	258	190
2508591	GED0137182S	22	292	300
2508583	GED0137184S	24	318	370
2508575	GED0137187S	27	352	500
2508559	GED0137190S	30	390	645
2508540	GED0137191S	32	412	780

GED0137

COMBINATION SPANNER SET, OFFSET

- Sets of the most used sizes



 mm

Code	No.	Contents	pieces	l mm
2497468	GED0137206S	10 12 13 17 19 22	6	845
2493349	GED0137208S	10 12 13 17 19 22 14 27 30 32	10	3140

RINGSPANNERS NON-SPARKING

GED011

DOUBLE ENDED RING SPANNER OFFSET

- Offset, bi-hexagon
- Specialist for extremely deep or inset nuts



 mm

Code	No.	Ø mm	l mm	l mm
2497573	GED0110607S	6 x 7	170	105
2497557	GED0110608S	6 x 8	170	110
2497549	GED0110708S	7 x 8	170	100
2497530	GED0110709S	7 x 9	170	100
2497522	GED0110809S	8 x 9	170	100
2493993	GED0110810S	8 x 10	180	140
2493985	GED0110910S	9 x 10	180	125
2493977	GED0110911S	9 x 11	180	135
2520788	GED0111011S	10 x 11	180	145
2520753	GED0111012S	10 x 12	180	140
2520745	GED0111013S	10 x 13	195	175
2520737	GED0111014S	10 x 14	195	170
2520729	GED0111113S	11 x 13	195	190
2520710	GED0111114S	11 x 14	195	180

Code	No.	Ø mm	l mm	l mm
2520702	GED0111213S	12 x 13	195	180
2520699	GED0111214S	12 x 14	195	180
2520680	GED0111314S	13 x 14	195	175
2520672	GED0111315S	13 x 15	230	240
2520664	GED0111316S	13 x 16	230	240
2520648	GED0111317S	13 x 17	230	250
2520621	GED0111415S	14 x 15	230	250
2520613	GED0111416S	14 x 16	230	240
2520605	GED0111417S	14 x 17	230	230
2520591	GED0111617S	16 x 17	230	240
2520583	GED0111618S	16 x 18	280	420
2520575	GED0111719S	17 x 19	280	400
2520567	GED0111722S	17 x 22	280	380
2520559	GED0111819S	18 x 19	280	400
2520540	GED0111820S	18 x 20	280	390
2520516	GED0111821S	18 x 21	280	390
2520508	GED0111922S	19 x 22	280	370
2520494	GED0111924S	19 x 24	290	530
2520486	GED0112022S	20 x 22	280	380
2520478	GED0112123S	21 x 23	290	510
2520451	GED0112124S	21 x 24	300	510
2520443	GED0112224S	22 x 24	300	510
2520435	GED0112227S	22 x 27	330	650
2520427	GED0112326S	23 x 26	330	670
2520419	GED0112426S	24 x 26	330	680
2520397	GED0112427S	24 x 27	330	670
2520389	GED0112430S	24 x 30	370	930
2520370	GED0112528S	25 x 28	330	660
2520362	GED0112629S	26 x 29	370	1000
2520354	GED0112729S	27 x 29	370	1000
2520346	GED0112730S	27 x 30	370	900
2520338	GED0112732S	27 x 32	370	900
2520311	GED0113032S	30 x 32	370	860
2520303	GED0113034S	30 x 34	430	850
2520281	GED0113036S	30 x 36	430	1300
2520265	GED0113234S	32 x 34	430	1300
2520257	GED0113236S	32 x 36	430	1300
2520249	GED0113436S	34 x 36	430	1250
2520230	GED0113538S	35 x 38	450	1400
2520222	GED0113638S	36 x 38	450	1450
2520214	GED0113641S	36 x 41	450	1450
2520206	GED0113842S	38 x 42	450	1450
2520192	GED0114146S	41 x 46	460	1800
2520184	GED0114650S	46 x 50	480	2100
2520176	GED0115055S	50 x 55	540	3000
2520141	GED0115060S	50 x 60	540	2800
2520133	GED0115560S	55 x 60	540	2800
2520125	GED0116065S	60 x 65	690	4200
2520117	GED0116570S	65 x 70	690	4200
2520109	GED0117080S	70 x 80	770	6000
2520087	GED0117580S	75 x 80	790	6600
2520079	GED0118590S	85 x 90	800	7000

GED011

DOUBLE ENDED RING SPANNER SET, OFFSET, 12 PIECES

- Sets of the most used sizes



 mm

Code	No.	Contents	l mm
2516454	GED0110000S	6x7 8x9 10x11 12x13 14x15 16x17 18x19 20x22 21x23 24x27 25x28 30x32	4100

GED011

DOUBLE ENDED RING SPANNER OFFSET INCH

- Offset, bi-hexagon
- Specialist for extremely deep or inset nuts



"AF

Code	No.	"AF	(mm)	
2510391	GED0117101S	1/4 x 5/16	170	110
2510286	GED0117102S	5/16 x 3/8	170	100
2510162	GED0117103S	3/8 x 7/16	180	135
2510030	GED0117104S	7/16 x 1/2	195	190
2509911	GED0117105S	1/2 x 9/16	195	175
2493306	GED0117113S	1/2 x 19/32	230	240
2509784	GED0117106S	9/16 x 5/8	230	250
2511134	GED0117107S	19/32 x 11/16	230	230
2493438	GED0117108S	5/8 x 11/16	230	240
2516446	GED0117109S	5/8 x 3/4	280	400
2493187	GED0117114S	11/16 x 3/4	280	400
2509903	GED0117115S	11/16 x 25/32	280	380
2493055	GED0117116S	3/4 x 25/32	280	360
2516438	GED0117110S	3/4 x 7/8	280	370
2492946	GED0117117S	13/16 x 7/8	280	380
2508680	GED0117118S	25/32 x 13/16	280	350
2492814	GED0117119S	7/8 x 15/16	300	510
2493969	GED0117120S	7/8 x 1	300	500
2518708	GED0117121S	7/8 x 1.1/16	330	650
2516411	GED0117111S	15/16 x 1	330	670
2516403	GED0117122S	1 x 1.1/8	330	660
2494027	GED0117123S	1.1/16 x 1.1/8	370	1000
2495252	GED0117112S	1.1/16 x 1.1/4	370	900
2492806	GED0117124S	1.1/8 x 1.5/16	370	880
2515644	GED0117125S	1.3/16 x 1.5/16	430	850
2491583	GED0117126S	1.1/4 x 1.5/16	430	1200
2507455	GED0117127S	1.1/4 x 1.3/8	430	1300
2522969	GED0117128S	1.1/4 x 1.7/16	430	1300
2521733	GED0117129S	1.5/16 x 1.1/2	430	1200
2506246	GED0117130S	1.3/8 x 1.1/2	450	1400
2520524	GED0117131S	1.7/16 x 1.5/8	450	1450
2503794	GED0117132S	1.5/8 x 1.13/16	460	1800
2491575	GED0117133S	1.11/16 x 1.7/8	460	1800
2492687	GED0117134S	1.13/16 x 2	480	2100
2519291	GED0117135S	1.3/4 x 2.1/16	480	2000
2509660	GED0117136S	2 x 2.3/16	540	3000
2516381	GED0117137S	2 x 2.3/8	540	2800
2518082	GED0117138S	2.3/16 x 2.3/8	540	2800
2516853	GED0117139S	2.1/4 x 2.7/16	540	2700

GED011

DOUBLE ENDED RING SPANNER SET, OFFSET INCH, 8 PIECES

- Sets of the most used sizes



"AF

Code	No.	Contents	
2520095	GED0117100S	1/4x5/16 3/8x7/16 7/16x1/2 1/2x9/16 9/16x5/8 5/8x11/16 3/4x7/8 15/16x1AF	2100

GED012

DOUBLE ENDED RING SPANNER STRAIGHT

- Flat, bi-hexagon



mm

Code	No.	mm	(mm)	
2501155	GED0120607S	6 x 7	100	12
2501147	GED0120809S	8 x 9	115	16
2497514	GED0120810S	8 x 10	120	20
2497506	GED0120911S	9 x 11	125	22
2493950	GED0121011S	10 x 11	130	24
2493942	GED0121013S	10 x 13	130	24
2493934	GED0121213S	12 x 13	140	40
2493926	GED0121214S	12 x 14	140	45
2493896	GED0121314S	13 x 14	140	45
2493888	GED0121315S	13 x 15	140	45
2493861	GED0121317S	13 x 17	155	50
2493853	GED0121415S	14 x 15	155	48
2493845	GED0121417S	14 x 17	155	50
2493837	GED0121617S	16 x 17	170	70
2493829	GED0121618S	16 x 18	170	65
2493810	GED0121719S	17 x 19	190	80
2493802	GED0121819S	18 x 19	190	80
2493799	GED0121922S	19 x 22	200	120
2493772	GED0121924S	19 x 24	200	120
2493764	GED0122022S	20 x 22	200	120
2493756	GED0122123S	21 x 23	200	120
2493748	GED0122224S	22 x 24	200	120
2493721	GED0122426S	24 x 26	210	135
2493713	GED0122427S	24 x 27	210	130
2493705	GED0122430S	24 x 30	255	185
2493691	GED0122528S	25 x 28	255	200
2493683	GED0122628S	26 x 28	255	190
2493675	GED0122729S	27 x 29	255	185
2493659	GED0122732S	27 x 32	265	228
2493640	GED0123032S	30 x 32	265	228
2493632	GED0123036S	30 x 36	285	284
2493624	GED0123236S	32 x 36	285	284
2493616	GED0123641S	36 x 41	460	330
2493608	GED0124146S	41 x 46	432	810
2493594	GED0124650S	46 x 50	477	1040



GED012

DOUBLE ENDED RING SPANNER STRAIGHT INCH

Flat, bi-hexagon



 "AF

Code	No.	O"AF	(mm)	±
2516365	GED01200015	1/4 x 5/16	100	12
2516357	GED01200025	5/16 x 3/8	115	16
2516349	GED01200035	3/8 x 7/16	125	22
2509539	GED01200045	7/16 x 9/16	140	45
2520060	GED01200055	1/2 x 5/8	155	50
2509415	GED01200065	1/2 x 19/32	140	45
2492555	GED01200075	9/16 x 11/16	155	50
2509296	GED01200085	5/8 x 25/32	190	80
2509172	GED01200095	11/16 x 3/4	190	80
2520052	GED01200105	3/4 x 7/8	200	120
2518589	GED01200115	13/16 x 15/16	200	120
2505010	GED01200125	15/16 x 1.1/16	210	130
2520036	GED01200135	1 x 1.1/8	255	200
2503808	GED01200145	1.3/16 x 1.1/4	265	228

GED009

SINGLE ENDED RING SPANNER STRAIGHT

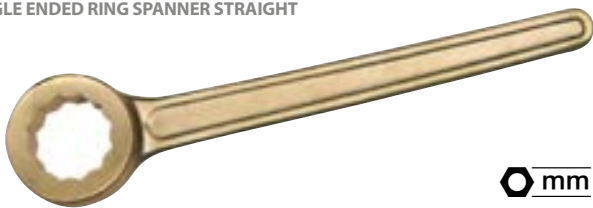

 mm

Code	No.	O mm	(mm)	±
2502038	GED00900145	14	140	130
2502011	GED00900155	15	140	130
2502003	GED00900165	16	155	150
2501996	GED00900175	17	155	150
2501988	GED00900185	18	170	250
2501961	GED00900195	19	170	280
2501945	GED00900205	20	190	280
2501937	GED00900215	21	190	300
2501929	GED00900225	22	190	300
2501910	GED00900235	23	215	300
2501902	GED00900245	24	215	400
2501899	GED00900255	25	230	430
2501880	GED00900265	26	230	450
2501872	GED00900275	27	230	500
2501864	GED00900285	28	265	520
2501856	GED00900295	29	265	510
2501821	GED00900305	30	265	500
2501813	GED00900325	32	265	450
2501805	GED00900335	33	265	430
2501791	GED00900345	34	290	670
2501783	GED00900355	35	290	660
2501775	GED00900365	36	290	650
2501767	GED00900375	37	325	900
2501759	GED00900385	38	325	900
2501740	GED00900415	41	325	900
2501732	GED00900425	42	325	900
2501716	GED00900465	46	365	1100
2501708	GED00900475	47	365	1100
2501694	GED00900505	50	400	1400
2501686	GED00900525	52	430	1800
2501678	GED00900545	54	430	1700
2501651	GED00900555	55	445	1650
2501643	GED00900565	56	465	1800
2501635	GED00900585	58	465	1800

Code	No.	O mm	(mm)	±
2501627	GED00900605	60	465	2000
2501619	GED00900635	63	500	2300
2501597	GED00900655	65	500	2100
2501589	GED00900675	67	500	2000
2501570	GED00900705	70	550	3000
2501562	GED00900715	71	550	2800
2501554	GED00900755	75	620	5000
2501546	GED00900775	77	620	5000
2501538	GED00900805	80	620	4500
2501511	GED00900825	82	620	4300
2501503	GED00900855	85	650	5000
2501481	GED00900885	88	650	4800
2501465	GED00900905	90	650	4200
2501457	GED00900945	94	700	5200
2501449	GED00900955	95	700	5200

GED009

SINGLE ENDED RING SPANNER STRAIGHT INCH

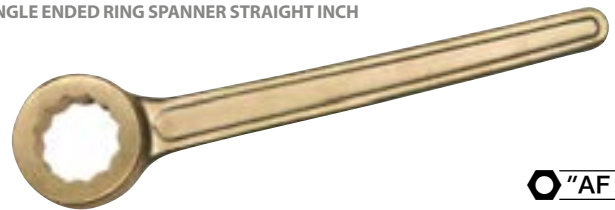

 "AF

Code	No.	O"AF	(mm)	±
2502070	GED00900015	1/2	140	130
2497913	GED00900025	9/16	140	130
2494388	GED00900035	19/32	140	130
2502062	GED00900045	5/8	155	150
2494361	GED00900055	11/16	155	150
2502054	GED00900065	3/4	170	280
2494353	GED00900075	25/32	190	280
2494345	GED00900085	13/16	190	300
2502046	GED00900095	7/8	190	300
2494337	GED00900105	15/16	215	400
2494329	GED00900115	31/32	215	430
2507021	GED00900125	1	230	430
2521148	GED00900135	1.1/16	230	500
2494310	GED00900965	1.1/8	265	520
2521113	GED00900975	1.3/16	265	500
2494302	GED00900985	1.1/4	265	450
2521105	GED00900995	1.5/16	265	430
2494299	GED00901005	1.3/8	290	660
2521091	GED00901015	1.7/16	325	900
2494280	GED00901025	1.1/2	325	900
2521083	GED00901035	1.9/16	325	850
2494264	GED00901045	1.5/8	325	900
2516527	GED00901055	1.11/16	325	850
2494256	GED00901065	1.3/4	365	1200
2516519	GED00901075	1.13/16	365	1100
2494248	GED00901085	1.7/8	365	1100
2507013	GED00901095	2	400	1400
2521075	GED00901105	2.1/16	430	1800
2494221	GED00901115	2.1/8	430	1700
2521067	GED00901125	2.3/16	445	1650
2494213	GED00901135	2.1/4	465	1800
2521059	GED00901145	2.5/16	465	1800
2494205	GED00901155	2.3/8	465	2000
2521040	GED00901165	2.7/16	500	2100
2494191	GED00901175	2.1/2	500	2000
2521032	GED00901185	2.9/16	500	2100
2494183	GED00901195	2.3/4	550	3000
2516497	GED00901205	2.15/16	620	5000
2507005	GED00901215	3	620	5000
2494175	GED00901225	3.1/8	620	4500
2494167	GED00901235	3.3/8	650	5000
2494140	GED00901245	3.1/2	650	4800
2494132	GED00901255	3.3/4	700	5200

SLOGGING SPANNERS NON-SPARKING

GED003

OPEN ENDED SLOGGING SPANNER
 ▽ For very heavy-duty work



mm

Code	No.	Ø mm	l mm	l ₁ mm
2505312	GED0030014S	14	180	350
2505304	GED0030017S	17	125	120
2505290	GED0030019S	19	120	125
2505282	GED0030022S	22	135	150
2505266	GED0030024S	24	150	200
2505258	GED0030027S	27	180	380
2505231	GED0030028S	28	180	370
2505223	GED0030029S	29	190	360
2505215	GED0030030S	30	190	350
2505207	GED0030032S	32	210	680
2505193	GED0030033S	33	210	670
2505185	GED0030034S	34	210	660
2505177	GED0030035S	35	210	650
2505169	GED0030036S	36	210	640
2505142	GED0030038S	38	210	630
2505134	GED0030041S	41	220	790
2505126	GED0030042S	42	220	750
2505118	GED0030046S	46	250	1150
2505096	GED0030047S	47	255	1200
2505088	GED0030050S	50	275	1350
2505061	GED0030052S	52	275	1500
2505053	GED0030054S	54	300	1900
2505045	GED0030055S	55	290	1600
2505037	GED0030056S	56	290	1550
2505002	GED0030058S	58	290	1500
2504995	GED0030060S	60	320	2600
2504987	GED0030063S	63	330	3000
2504979	GED0030065S	65	330	3000
2504960	GED0030067S	67	380	4200
2504952	GED0030070S	70	380	3800
2504944	GED0030071S	71	380	3700
2504936	GED0030075S	75	380	3600
2504928	GED0030077S	77	380	5000
2504901	GED0030080S	80	370	4800
2504871	GED0030082S	82	370	4700
2504863	GED0030085S	85	370	4500
2504855	GED0030088S	88	430	7200
2504847	GED0030090S	90	430	7000
2504839	GED0030094S	94	430	6900
2504820	GED0030095S	95	430	6800
2502364	GED0030100S	100	470	9500
2502356	GED0030105S	105	470	9300
2502348	GED0030110S	110	510	14100
2502321	GED0030115S	115	510	13300
2502305	GED0030120S	120	545	16400
2502291	GED0030125S	125	545	15500
2502283	GED0030130S	130	575	19800
2502275	GED0030135S	135	575	19200
2502267	GED0030140S	140	575	19000
2502259	GED0030145S	145	640	27000
2502240	GED0030150S	150	640	26800
2502232	GED0030155S	155	640	26500

Code	No.	Ø mm	l mm	l ₁ mm
2502224	GED0030160S	160	640	26300
2502216	GED0030165S	165	715	39500
2502194	GED0030170S	170	715	38500
2502186	GED0030175S	175	715	37000
2502178	GED0030180S	180	715	36000
2502151	GED0030185S	185	715	35800
2502143	GED0030190S	190	715	38500
2502135	GED0030195S	195	715	38500
2502127	GED0030200S	200	715	38000
2502119	GED0030205S	205	715	37500
2502100	GED0030210S	210	715	37000
2502410	GED0020220S	220	715	36500
2502097	GED0030230S	230	715	36500

GED003

OPEN ENDED SLOGGING SPANNER INCH
 ▽ For very heavy-duty work



"AF

Code	No.	Ø "AF	l mm	l ₁ mm
2509237	GED0030001S	1	150	200
2494507	GED0030002S	1.1/16	180	380
2498197	GED0030003S	1.1/8	180	370
2494493	GED0030004S	1.3/16	190	350
2498170	GED0030005S	1.1/4	210	680
2494485	GED0030006S	1.5/16	210	670
2498162	GED0030007S	1.3/8	210	650
2494477	GED0030008S	1.7/16	210	640
2498154	GED0030009S	1.1/2	210	630
2494418	GED0030252S	1.9/16	220	750
2498146	GED0030010S	1.5/8	220	790
2521180	GED0030011S	1.11/16	220	750
2498138	GED0030012S	1.3/4	250	1100
2521172	GED0030013S	1.13/16	250	1150
2498111	GED0030231S	1.7/8	255	1200
2509229	GED0030232S	2	275	1350
2494469	GED0030233S	2.1/16	275	1500
2498103	GED0030234S	2.1/8	300	1900
2494450	GED0030235S	2.3/16	290	1600
2498081	GED0030236S	2.1/4	290	1500
2494442	GED0030237S	2.5/16	290	1500
2497964	GED0030253S	2.3/8	320	2600
2494434	GED0030238S	2.7/16	330	3000
2497956	GED0030254S	2.1/2	330	3000
2494426	GED0030239S	2.9/16	330	3000
2498073	GED0030240S	2.5/8	380	4200
2498065	GED0030241S	2.3/4	380	3800
2521164	GED0030255S	2.13/16	380	3700
2521156	GED0030256S	2.15/16	380	3500
2509210	GED0030242S	3	380	4000
2498049	GED0030243S	3.1/8	370	4800
2498030	GED0030244S	3.1/4	370	4700
2498022	GED0030245S	3.3/8	370	4500
2498014	GED0030246S	3.1/2	430	7200
2498006	GED0030247S	3.5/8	430	7000
2497999	GED0030248S	3.3/4	430	6800
2497921	GED0030257S	3.7/8	430	6600
2509202	GED0030249S	4	470	9500
2497980	GED0030250S	4.1/8	470	9500
2497972	GED0030251S	4.1/2	510	13300

GED010

RING SLOGGING SPANNER

► For very heavy-duty work



 mm

Code	No.	Ø mm	(=mm=)	↕
2504812	GED01000175	17	150	400
2504804	GED01000195	19	150	400
2504790	GED01000225	22	150	350
2504782	GED01000245	24	150	350
2504766	GED01000275	27	190	600
2504758	GED01000285	28	190	580
2504731	GED01000295	29	190	560
2504723	GED01000305	30	190	550
2504715	GED01000325	32	190	580
2504707	GED01000335	33	190	570
2504693	GED01000345	34	210	680
2504685	GED01000355	35	210	700
2504677	GED01000365	36	210	690
2504669	GED01000375	37	210	680
2504642	GED01000385	38	230	1100
2504634	GED01000415	41	230	1000
2504626	GED01000425	42	230	1000
2504618	GED01000465	46	240	1250
2504596	GED01000475	47	240	1270
2504588	GED01000505	50	255	1400
2504561	GED01000525	52	255	1400
2504553	GED01000545	54	255	1350
2504545	GED01000555	55	255	1340
2504537	GED01000565	56	255	1330
2504510	GED01000575	57	255	1300
2504502	GED01000585	58	280	2500
2504499	GED01000605	60	280	2400
2504480	GED01000635	63	295	2900
2504472	GED01000655	65	295	2800
2504464	GED01000675	67	295	2700
2504456	GED01000705	70	320	3400
2504448	GED01000715	71	320	3300
2504421	GED01000755	75	320	3200
2504413	GED01000765	76	320	3100
2504391	GED01000775	77	320	3000
2504383	GED01000805	80	355	3600
2504375	GED01000825	82	355	3500
2504367	GED01000855	85	365	5000
2504359	GED01000885	88	360	4800
2504340	GED01000905	90	360	4600
2504332	GED01000945	94	360	4500
2504324	GED01000955	95	360	4400
2501430	GED01001005	100	360	4200
2501422	GED01001055	105	360	3900
2501414	GED01001105	110	450	8600
2501406	GED01001155	115	450	8100
2501392	GED01001205	120	480	9700
2501384	GED01001255	125	480	9500
2501376	GED01001285	128	520	13200
2501333	GED01001305	130	520	13200
2501325	GED01001355	135	520	12900
2501317	GED01001405	140	520	12900
2501309	GED01001455	145	580	19000
2501295	GED01001505	150	580	18000
2501287	GED01001555	155	580	17200
2501279	GED01001605	160	580	19000
2501260	GED01001655	165	650	28000

Code	No.	Ø mm	(=mm=)	↕
2501252	GED01001705	170	650	27700
2501244	GED01001755	175	650	27000
2501228	GED01001805	180	650	26000
2501201	GED01001855	185	700	32700
2501198	GED01001905	190	700	32200
2501171	GED01001955	195	700	31800
2501163	GED01002005	200	700	31000

GED010

RING SLOGGING SPANNER INCH

► For very heavy-duty work



 "AF

Code	No.	Ø "AF	(=mm=)	↕
2497883	GED01002015	1 1/16	150	400
2504316	GED01002025	3/4	150	400
2497875	GED01002035	25/32	150	390
2497867	GED01002045	13/16	150	380
2504308	GED01002055	7/8	150	350
2497859	GED01002065	15/16	150	350
2509199	GED01002075	1	150	340
2494094	GED01002085	1.1/16	190	700
2497840	GED01002095	1.1/8	190	580
2497832	GED01002105	1.1/4	190	580
2494086	GED01002115	1.3/16	190	550
2494124	GED01000065	1.5/16	190	570
2497816	GED01002125	1.3/8	210	700
2494116	GED01000085	1.7/16	210	690
2497905	GED01000095	1.1/2	230	1100
2494108	GED01000105	1.9/16	230	1000
2497808	GED01002135	1.5/8	230	1000
2521024	GED01002145	1.11/16	230	1000
2497891	GED01000135	1.3/4	240	1200
2521008	GED01002155	1.13/16	240	1250
2497794	GED01002165	1.7/8	240	1270
2509180	GED01002175	2	255	1400
2494043	GED01002335	2.1/16	255	1400
2497786	GED01002185	2.1/8	255	1350
2494078	GED01002195	2.3/16	255	1340
2497778	GED01002205	2.1/4	255	1300
2494019	GED01002345	2.5/16	280	2500
2497751	GED01002215	2.3/8	280	2400
2494000	GED01002355	2.7/16	295	2700
2497662	GED01002365	2.1/2	295	2900
2494051	GED01002225	2.9/16	295	2800
2497743	GED01002235	2.5/8	295	2700
2497735	GED01002245	2.3/4	320	3200
2520982	GED01002375	2.13/16	320	3300
2497727	GED01002255	2.7/8	320	3300
2520990	GED01002265	2.15/16	320	3200
2509164	GED01002275	3	320	3100
2497719	GED01002305	3.1/8	355	3600
2497654	GED01002385	3.1/4	355	3500
2497646	GED01002395	3.3/8	365	5000
2497638	GED01002405	3.1/2	360	4800
2497611	GED01002415	3.5/8	360	4500
2497689	GED01002315	3.3/4	360	4500
2497670	GED01002325	3.7/8	360	4300
2509156	GED01002425	4	360	4200
2497603	GED01002435	4.1/8	360	3900
2497581	GED01002445	4.1/2	450	8100

GED010

RING SLOGGING SPANNER OFFSET

For very heavy-duty work



mm

Code	No.	Ø mm	l mm	l mm	l mm
2520974	GED0100250S	27	245	1100	
2520966	GED0100251S	30	270	1500	
2520958	GED0100252S	32	270	1500	
2520931	GED0100253S	36	280	1600	
2520923	GED0100254S	41	310	2100	
2520915	GED0100255S	46	320	2500	
2520907	GED0100256S	50	320	2500	
2520885	GED0100257S	55	320	2600	
2520877	GED0100258S	60	355	3200	
2520869	GED0100259S	65	380	3800	
2520850	GED0100260S	70	400	4600	
2520842	GED0100261S	75	420	5700	
2520834	GED0100262S	80	440	6600	
2520826	GED0100263S	85	440	7000	
2520818	GED0100264S	90	440	9300	
2520796	GED0100265S	95	440	10000	
2516489	GED0100266S	100	440	11700	
2516470	GED0100267S	110	440	13400	
2516462	GED0100268S	115	440	14500	

GED031

OPEN ENDED SPANNER

Jaw alternatively set at 90°, 45° or 15°

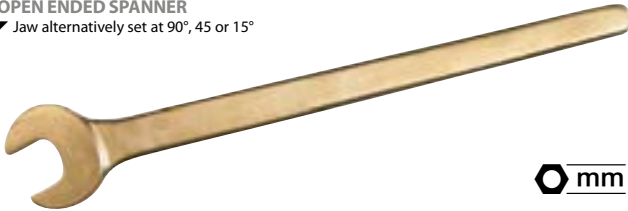

mm

Code	No.	Degree	Ø mm	l mm	l mm
2519208	GED03100225-15	15	22	320	450
2519151	GED03100235-15	15	23	320	450
2519127	GED03100245-15	15	24	350	600
2519097	GED03100255-15	15	25	350	600
2519054	GED03100265-15	15	26	380	850
2519011	GED03100275-15	15	27	380	850
2518988	GED03100285-15	15	28	420	1000
2520028	GED03100295-15	45	29	420	1000
2518945	GED03100305-15	15	30	420	1000
2518902	GED03100325-15	15	32	450	1000
2518872	GED03100335-15	15	33	450	1000
2518848	GED03100345-15	15	34	450	1000
2518791	GED03100355-15	15	35	500	1400
2518767	GED03100365-15	15	36	500	1400
2518732	GED03100375-15	15	37	500	1400
2518694	GED03100385-15	15	38	500	1400
2518651	GED03100415-15	15	41	550	1800
2518627	GED03100425-15	15	42	550	1800
2518597	GED03100465-15	15	46	600	2500
2518554	GED03100475-15	15	47	600	2500
2518511	GED03100505-15	15	50	660	3200
2518473	GED03100525-15	15	52	660	3200
2518430	GED03100545-15	15	54	660	4400
2518406	GED03100555-15	15	55	730	4400
2518376	GED03100565-15	15	56	730	4400
2518325	GED03100585-15	15	58	800	5600
2518295	GED03100605-15	15	60	800	5600



Code	No.	Degree	Ø mm	l mm	l mm
2519194	GED03100225-45	45	22	320	450
2519143	GED03100235-45	45	23	320	450
2519119	GED03100245-45	45	24	350	600
2519089	GED03100255-45	45	25	350	600
2519046	GED03100265-45	45	26	380	850
2519003	GED03100275-45	45	27	380	850
2518961	GED03100285-45	45	28	420	1000
2520001	GED03100295-45	45	29	420	1000
2518929	GED03100305-45	45	30	420	1000
2518899	GED03100325-45	45	32	450	1000
2518864	GED03100335-45	45	33	450	1000
2518821	GED03100345-45	45	34	450	1000
2518783	GED03100355-45	45	35	500	1400
2518759	GED03100365-45	45	36	500	1400
2518724	GED03100375-45	45	37	500	1400
2518686	GED03100385-45	45	38	500	1400
2518643	GED03100415-45	45	41	550	1800
2518619	GED03100425-45	45	42	550	1800
2518570	GED03100465-45	45	46	600	2500
2518546	GED03100475-45	45	47	600	2500
2518503	GED03100505-45	45	50	660	3200
2518465	GED03100525-45	45	52	660	3200
2518422	GED03100545-45	45	54	660	4400
2518392	GED03100555-45	45	55	730	4400
2518368	GED03100565-45	45	56	730	4400
2518317	GED03100585-45	45	58	800	5600
2518287	GED03100605-45	45	60	800	5600
2519178	GED03100225-90	90	22	320	450
2519135	GED03100235-90	90	23	320	450
2519100	GED03100245-90	90	24	350	600
2519070	GED03100255-90	90	25	350	600
2519038	GED03100265-90	90	26	380	850
2518996	GED03100275-90	90	27	380	850
2518953	GED03100285-90	90	28	420	1000
2519992	GED03100295-90	90	29	420	1000
2518910	GED03100305-90	90	30	420	1000
2518880	GED03100325-90	90	32	450	1000
2518856	GED03100335-90	90	33	450	1000
2518805	GED03100345-90	90	34	450	1000
2518775	GED03100355-90	90	35	500	1400
2518740	GED03100365-90	90	36	500	1400
2518716	GED03100375-90	90	37	500	1400
2518678	GED03100385-90	90	38	500	1400
2518635	GED03100415-90	90	41	550	1800
2518600	GED03100425-90	90	42	550	1800
2518562	GED03100465-90	90	46	600	2500
2518538	GED03100475-90	90	47	600	2500
2518481	GED03100505-90	90	50	660	3200
2518449	GED03100525-90	90	52	660	3200
2518414	GED03100545-90	90	54	660	4400
2518384	GED03100555-90	90	55	730	4400
2518341	GED03100565-90	90	56	730	4400
2518309	GED03100585-90	90	58	800	5600
2518279	GED03100605-90	90	60	800	5600

GED031

OPEN ENDED SPANNER INCH

▀ Jaw alternatively set at 90°, 45 or 15°



Code	No.	Degree	⌀ ^{AF}	↳mm↳	↳mm↳
2492431	GED0310001S-15	15	13/16	320	450
2516098	GED0310002S-15	15	7/8	320	450
2492075	GED0310003S-15	15	15/16	350	600
2491710	GED0310004S-15	15	31/32	350	600
2492296	GED0310005S-15	15	1	350	600
2518333	GED0310006S-15	15	1.1/16	380	850
2523930	GED0310007S-15	15	1.1/8	420	1000
2517957	GED0310008S-15	15	1.3/16	450	1000
2523574	GED0310009S-15	15	1.1/4	450	1000
2517590	GED0310010S-15	15	1.5/16	450	1000
2523205	GED0310011S-15	15	1.3/8	500	1400
2517221	GED0310012S-15	15	1.7/16	500	1400
2522837	GED0310013S-15	15	1.1/2	500	1400
2516861	GED0310014S-15	15	1.9/16	550	1800
2522489	GED0310015S-15	15	1.5/8	550	1800
2502569	GED0310016S-15	15	1.11/16	550	1800
2522128	GED0310017S-15	15	1.3/4	600	2500
2498901	GED0310018S-15	15	1.13/16	600	2500
2521741	GED0310019S-15	15	1.7/8	600	2500
2492253	GED0310020S-15	15	2	660	3200
2516500	GED0310021S-15	15	2.1/16	660	3200
2521377	GED0310061S-15	15	2.1/8	660	4400
2516144	GED0310062S-15	15	2.3/16	730	4400
2521016	GED0310063S-15	15	2.1/4	800	4400
2515776	GED0310064S-15	15	2.5/16	800	5600
2520656	GED0310065S-15	15	2.3/8	800	5600

Code	No.	Degree	⌀ ^{AF}	↳mm↳	↳mm↳
2492326	GED0310001S-45	45	13/16	320	450
2516071	GED0310002S-45	45	7/8	320	450
2491966	GED0310003S-45	45	15/16	350	600
2491591	GED0310004S-45	45	31/32	350	600
2492288	GED0310005S-45	45	1	350	600
2518228	GED0310006S-45	45	1.1/16	380	850
2523817	GED0310007S-45	45	1.1/8	420	1000
2517833	GED0310008S-45	45	1.3/16	450	1000
2523450	GED0310009S-45	45	1.1/4	450	1000
2517477	GED0310010S-45	45	1.5/16	450	1000
2523094	GED0310011S-45	45	1.3/8	500	1400
2517116	GED0310012S-45	45	1.7/16	500	1400
2522713	GED0310013S-45	45	1.1/2	500	1400
2516748	GED0310014S-45	45	1.9/16	550	1800
2522357	GED0310015S-45	45	1.5/8	550	1800
2501341	GED0310016S-45	45	1.11/16	550	1800
2521997	GED0310017S-45	45	1.3/4	600	2500
2497697	GED0310018S-45	45	1.13/16	600	2500
2521628	GED0310019S-45	45	1.7/8	600	2500
2492245	GED0310020S-45	45	2	660	3200
2516373	GED0310021S-45	45	2.1/16	660	3200
2521245	GED0310061S-45	45	2.1/8	660	4400
2516012	GED0310062S-45	45	2.3/16	730	4400
2520893	GED0310063S-45	45	2.1/4	800	4400
2515652	GED0310064S-45	45	2.5/16	800	5600
2520532	GED0310065S-45	45	2.3/8	800	5600

Code	No.	Degree	⌀ ^{AF}	↳mm↳	↳mm↳
2492199	GED0310001S-90	90	13/16	320	450
2516063	GED0310002S-90	90	7/8	320	450
2491842	GED0310003S-90	90	15/16	350	600
2524066	GED0310004S-90	90	31/32	350	600
2492261	GED0310005S-90	90	1	350	600
2518090	GED0310006S-90	90	1.1/16	380	850
2523698	GED0310007S-90	90	1.1/8	420	1000
2517728	GED0310008S-90	90	1.3/16	450	1000
2523329	GED0310009S-90	90	1.1/4	450	1000
2517345	GED0310010S-90	90	1.5/16	450	1000
2522977	GED0310011S-90	90	1.3/8	500	1400
2516993	GED0310012S-90	90	1.7/16	500	1400
2522608	GED0310013S-90	90	1.1/2	500	1400
2516624	GED0310014S-90	90	1.9/16	550	1800
2522233	GED0310015S-90	90	1.5/8	550	1800
2500124	GED0310016S-90	90	1.11/16	550	1800
2521865	GED0310017S-90	90	1.3/4	600	2500
2496453	GED0310018S-90	90	1.13/16	600	2500
2521490	GED0310019S-90	90	1.7/8	600	2500
2492237	GED0310020S-90	90	2	660	3200
2516268	GED0310021S-90	90	2.1/16	660	3200
2521121	GED0310061S-90	90	2.1/8	660	4400
2515881	GED0310062S-90	90	2.3/16	730	4400
2520761	GED0310063S-90	90	2.1/4	800	4400
2514796	GED0310064S-90	90	2.5/16	800	5600
2520400	GED0310065S-90	90	2.3/8	800	5600



GED027

DEEP RING SPANNER

Offset, bi-hexagon



mm

Code	No.	Ø mm	l mm	l ₁ mm
2510790	GED0270025S	22	260	960
2510804	GED0270024S	24	260	1000
2510782	GED0270027S	27	260	960
2510774	GED0270030S	30	260	950
2510758	GED0270032S	32	260	940
2510731	GED0270033S	33	260	920
2510723	GED0270034S	34	260	910
2510715	GED0270035S	35	260	910
2510707	GED0270036S	36	260	910
2510693	GED0270037S	37	270	1200
2510685	GED0270038S	38	270	1900
2510677	GED0270041S	41	270	1100
2510669	GED0270042S	42	270	1100
2510650	GED0270046S	46	300	1500
2510634	GED0270047S	47	300	1500
2510626	GED0270050S	50	300	1700
2510618	GED0270052S	52	350	2600
2510596	GED0270054S	54	350	2500
2510588	GED0270055S	55	300	1900
2510561	GED0270056S	56	350	2600
2510553	GED0270058S	58	350	2500
2510545	GED0270060S	60	370	2500
2510537	GED0270063S	63	370	2500
2510529	GED0270065S	65	400	3200
2510502	GED0270067S	67	400	3100
2510499	GED0270070S	70	400	3000
2510480	GED0270071S	71	400	2800
2510472	GED0270075S	75	400	2700
2510464	GED0270077S	77	400	2600
2510456	GED0270080S	80	410	5000
2510448	GED0270082S	82	410	5000
2510421	GED0270085S	85	410	5100
2510413	GED0270090S	90	410	5010
2510405	GED0270095S	95	410	4790
2508435	GED0270100S	100	412	4545

GED027

EXTENSION TUBE FOR DEEP RING SPANNERS

For extending the lever arm and applying higher forces

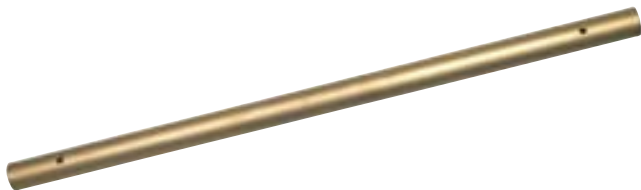

Code	No.	Ø	l mm	l ₁ mm	
2511967	GED0271001S	22 - 42 mm / 1.3/16 - 1.5/8AF	22	600	1100
2511959	GED0271002S	46 - 58 mm / 1.11/16 - 2.1/4AF	25	750	2800
2510383	GED0271003S	60 - 100 mm / 2.5/16 - 3.3/8AF	30	850	3800

GED027

DEEP RING SPANNER INCH

Offset, bi-hexagon



"AF

Code	No.	Ø "AF	l mm	l ₁ mm
2503913	GED0270001S	1.3/16	260	950
2506637	GED0270002S	1.1/4	260	940
2503905	GED0270003S	1.5/16	260	920
2506629	GED0270004S	1.3/8	260	910
2503891	GED0270005S	1.7/16	260	910
2506610	GED0270006S	1.1/2	270	1900
2503883	GED0270007S	1.9/16	270	1200
2506599	GED0270008S	1.5/8	270	1100
2499673	GED0270009S	1.11/16	270	1100
2506580	GED0270010S	1.3/4	270	1000
2499665	GED0270011S	1.13/16	300	1500
2506572	GED0270012S	1.7/8	300	1500
2513021	GED0270013S	2	300	1700
2503875	GED0270014S	2.1/16	350	2600
2506564	GED0270015S	2.1/8	350	2400
2503867	GED0270016S	2.3/16	300	1900
2506556	GED0270017S	2.1/4	350	2500
2503859	GED0270018S	2.5/16	350	2500
2506548	GED0270019S	2.3/8	370	2500
2503840	GED0270020S	2.7/16	370	2500
2506521	GED0270021S	2.1/2	370	2500
2503832	GED0270022S	2.9/16	400	3200
2506513	GED0270023S	2.5/8	400	3100
2506505	GED0270104S	2.3/4	400	3000
2499657	GED0270105S	2.13/16	400	2800
2499630	GED0270106S	2.15/16	400	2700
2513013	GED0270107S	3	400	2500
2506491	GED0270108S	3.1/8	410	4900
2506475	GED0270109S	3.1/4	410	5000
2506467	GED0270110S	3.3/8	410	5100

GED027

DEEP RING SPANNER SET, 18 PIECES

Sets of the most used sizes



mm

Code	No.	Contents	40200
2492318	GED0270111S	Spanners 24 - 27 - 30 - 32 - 36 41 - 46 - 50 - 55 - 60 65 - 70 - 75 - 80 - 85 Extension tubes 22 - 42 / 46 - 58 / 60 - 100	40200

INSTALLATION SPANNERS NON-SPARKING

GED01373

INSTALLATION OPEN-END SPANNER WITH MANDREL

► Practical combination of open ended spanner and setting punch



 mm

Code	No.	Ø mm	l mm	l ₁ mm
2501058	GED0137300S	17	320	270
2501031	GED0137301S	18	320	270
2501023	GED0137302S	19	350	465
2501015	GED0137303S	20	350	465
2501007	GED0137304S	21	350	465
2500981	GED0137305S	22	350	465
2500965	GED0137306S	23	370	650
2500957	GED0137307S	24	370	650
2500949	GED0137308S	25	370	650
2500930	GED0137309S	26	370	650
2500922	GED0137310S	27	370	650
2500914	GED0137311S	28	400	950
2500906	GED0137312S	29	400	950
2500892	GED0137313S	30	400	950
2500884	GED0137314S	32	400	950
2500876	GED0137315S	33	400	950
2500841	GED0137316S	34	400	950
2500833	GED0137317S	35	430	1400
2500825	GED0137318S	36	430	1400
2500817	GED0137319S	37	430	1400
2500809	GED0137320S	38	430	1400
2500795	GED0137321S	41	470	1900
2500787	GED0137322S	42	470	1900
2500779	GED0137323S	46	500	2700
2500760	GED0137324S	47	500	2700
2500752	GED0137325S	50	530	3550

GED01373

INSTALLATION OPEN-END SPANNER WITH MANDREL INCH

► Practical combination of open ended spanner and setting punch



 "AF

Code	No.	Ø "AF	l mm	l ₁ mm
2493330	GED0137326S	11/16	320	270
2500736	GED0137327S	3/4	350	270
2493322	GED0137328S	25/32	350	465
2493314	GED0137329S	13/16	350	465
2500728	GED0137330S	7/8	350	465
2493292	GED0137331S	15/16	370	465
2493284	GED0137332S	31/32	370	650
2506947	GED0137333S	1	370	650
2519984	GED0137334S	1.1/16	370	650
2493276	GED0137335S	1.1/8	400	650
2519976	GED0137336S	1.3/16	400	650
2493268	GED0137337S	1.1/4	400	950
2519968	GED0137338S	1.5/16	400	950
2493241	GED0137339S	1.3/8	430	950
2519941	GED0137340S	1.7/16	430	1400
2493233	GED0137341S	1.1/2	430	1400
2519933	GED0137342S	1.9/16	470	1400
2493225	GED0137343S	1.5/8	470	1900
2516330	GED0137344S	1.11/16	470	1900
2493217	GED0137345S	1.3/4	500	1900
2516322	GED0137346S	1.13/16	500	2700
2493209	GED0137347S	1.7/8	500	2700
2506939	GED0137348S	2	530	3550

GED01373

INSTALLATION OPEN-END SPANNER WITH MANDREL, OFFSET

► Practical combination of open ended spanner offset and setting punch



 mm

Code	No.	Ø mm	l mm	l ₁ mm
2500701	GED0137349S	17	320	295
2500698	GED0137350S	18	320	295
2500671	GED0137351S	19	350	510
2500663	GED0137352S	20	350	510
2500655	GED0137353S	21	350	510
2500647	GED0137354S	22	350	510
2500639	GED0137355S	23	370	715
2500620	GED0137356S	24	370	715
2500604	GED0137357S	25	370	715
2500590	GED0137358S	26	370	715
2500582	GED0137359S	27	370	715
2500574	GED0137360S	28	400	1145
2500566	GED0137361S	29	400	1145

Code	No.	Ø mm	l mm	l ₁ mm
2500558	GED0137362S	30	400	1145
2500531	GED0137363S	32	400	1145
2500523	GED0137364S	33	400	1145
2500515	GED0137365S	34	400	1145
2500507	GED0137366S	35	430	1540
2500485	GED0137367S	36	430	1540
2500477	GED0137368S	37	430	1540
2500469	GED0137369S	38	430	1540
2500450	GED0137370S	41	470	2090
2500442	GED0137371S	42	470	2090
2500434	GED0137372S	46	500	2970
2500426	GED0137373S	47	500	2970
2500418	GED0137374S	50	530	3900

GED01373

INSTALLATION OPEN-END SPANNER WITH MANDREL INCH, OFFSET

- Practical combination of open ended spanner offset and setting punch



⊙ "AF

Code	No.	⊙ "AF	l-mm	l
2493195	GED01373755	11/16	290	295
2500396	GED01373765	7/8	355	510
2493179	GED01373775	15/16	355	510
2519925	GED01373785	1.1/16	380	715
2519909	GED01373795	1.3/16	410	715
2493160	GED01373805	1.1/4	380	1145
2519895	GED01373815	1.7/16	460	1540
2493152	GED01373825	1.1/2	460	1145
2493144	GED01373835	1.5/8	510	2090
2516314	GED01373845	1.13/16	550	2970
2506920	GED01373855	2	550	3900

GED01375

INSTALLATION RING SPANNER WITH MANDREL INCH, OFFSET

- Practical combination of ring spanner offset and setting punch
- Bi-hexagon



⊙ "AF

Code	No.	⊙ "AF	l-mm	l
2492970	GED01375265	11/16	290	295
2500051	GED01375275	7/8	355	510
2492962	GED01375285	15/16	355	510
2519690	GED01375295	1.1/16	380	715
2519682	GED01375305	1.3/16	410	715
2492954	GED01375315	1.1/4	380	1145
2519666	GED01375325	5.7/16	460	1540
2492938	GED01375335	1.1/2	460	1145
2492911	GED01375345	1.5/8	510	2090
2516306	GED01375355	1.13/16	550	2970
2506912	GED01375365	2	550	3900

GED01375

INSTALLATION RING SPANNER WITH MANDREL, OFFSET

- Practical combination of ring spanner offset and setting punch
- Bi-hexagon



⊙ mm

Code	No.	⊙ mm	l-mm	l
2500388	GED01375005	17	320	295
2500353	GED01375015	18	320	295
2500345	GED01375025	19	350	510
2500337	GED01375035	20	350	510
2500329	GED01375045	21	350	510
2500310	GED01375055	22	350	510
2500302	GED01375065	23	370	715
2500299	GED01375075	24	370	715
2500280	GED01375085	25	370	715
2500272	GED01375095	26	370	715
2500264	GED01375105	27	370	715
2500248	GED01375115	28	400	1145
2500221	GED01375125	29	400	1145
2500213	GED01375135	30	400	1145
2500205	GED01375145	32	400	1145
2500191	GED01375155	33	400	1145
2500183	GED01375165	34	400	1145
2500175	GED01375175	35	430	1540
2500167	GED01375185	36	430	1540
2500159	GED01375195	37	430	1540
2500140	GED01375205	38	430	1540
2500116	GED01375215	41	470	2090
2500108	GED01375225	42	470	2090
2500094	GED01375235	46	500	2970
2500086	GED01375245	47	500	2970
2500078	GED01375255	50	530	3900

SPECIAL SPANNERS NON-SPARKING

GED703

COUPLING SPANNER

- For tank/truck (Storz) couplings A - B - C



Code	No.	⊙	l-mm	l
2511878	GED70304555	14	440	800

GED703

COUPLING SPANNER

- For tank/truck (Storz) couplings B - C
- PVC-insulated handle against cold



Code	No.	⊙	l-mm	l
2521954	GED70302855	12	280	450

GED091
SWIVEL-HEAD HOOK SPANNER



Code	No.	Ø	l-mm	l ₂
2517108	GED0913275S	50-120	285	450
2515407	GED0915012S	115-170	310	500
2496968	GED0911117S	32-75	205	230

GED702
VALVE HOOK



Code	No.	Ø	Distance	l-mm	l ₂
2512270	GED7021330S	13	30	300	350
2512262	GED7021335S	13	35	350	600
2512254	GED7021640S	16	40	400	680
2512246	GED7021645S	16	45	450	1100
2512211	GED7021950S	19	50	500	1200
2512203	GED7022260S	22	60	600	2000
2512181	GED7022570S	25	70	700	3000
2512173	GED7022880S	28	80	800	5300

GED090
HOOK SPANNER



Code	No.	Ø	l-mm	l ₂
2506068	GED0901214S	12-14	110	30
2506041	GED0901620S	16-20	110	30
2506033	GED0902528S	25-28	135	50
2506025	GED0903032S	30-32	135	50
2506017	GED0903436S	34-36	170	100
2506009	GED0904042S	40-42	170	100
2505983	GED0904550S	45-50	205	190
2505975	GED0905255S	52-55	205	190
2505967	GED0905862S	58-62	240	215
2505959	GED0906875S	68-75	240	200
2505940	GED0908090S	80-90	280	410
2503093	GED0909510S	95-100	280	410
2499045	GED0909700S	110-115	335	730
2499029	GED0909800S	120-130	335	730
2499010	GED0909900S	135-145	390	1150
2499002	GED0909990S	155-165	390	1150
2498995	GED0909991S	180-195	465	1410
2498987	GED0909992S	205-220	465	1385

GED703
FACE PIN SPANNER



Code	No.	Distance pin	l-mm	l ₂
2505452	GED9991024S	35	5	180 150

GED701
HANDWHEEL SPANNER
Analogous with DIN 87311



Code	No.	Ø	l-mm	l ₂
2498707	GED7013660S	36 x 60	370	650
2498693	GED7014880S	48 x 80	430	2600
2495546	GED7014810S	62 x 102	550	1300

GED700
SLIDE CLAW



Code	No.	Size	l-mm	l ₂
2509458	GED7000500S	30 - 40	500	720



GED9991

B-HANDWHEEL SPANNER



Code	No.	Ø	(mm)	mm
2521520	GED9991010S	36 x 60	330	600
2521512	GED9991011S	48 x 80	470	1400
2521504	GED9991012S	62 x 102	600	2600

GED9991

SPANNER FOR TANKER VALVE



Code	No.	Execution	Pin	External dimension	Opening	Handle	mm
2495430	GED9991007S	Type A	20	160 x 90	64 x 32	500	1800
2495422	GED9991008S	Type B	20	150 x 90	64 x 32	500	1600
2495414	GED9991009S	Type C	20	190 x 90	95 x 47,5	500	2500

GED0341

SQUARE SOCKET SPANNER ANGLED



Code	No.	Ø mm	(mm)	mm
2524031	GED0341110S	8	150	90
2524023	GED0341111S	9	160	100
2524015	GED0341112S	10	175	120
2523663	GED0341113S	12	215	220
2523647	GED0341114S	13	230	280
2523639	GED0341115S	14	240	280
2523620	GED0341116S	17	280	330

GED0359

TRIANGULAR SOCKET SPANNER SET 1/2"



Code	No.	□"	Size	(mm)	mm
2499037	GED0359502S	1/2	M6	40	70
2498928	GED0359503S	1/2	M8	40	75
2498782	GED0359504S	1/2	M10	40	80
2498669	GED0359505S	1/2	M12	40	90
2498537	GED0359506S	1/2	M16	50	150
2498413	GED0359507S	1/2	M20	50	215
2498308	GED0359508S	1/2	M24	60	435

GED0300

TRIANGULAR SOCKET SPANNER

- ▀ Analogous with DIN 22417
- ▀ With inserted-through, moveable sliding bar

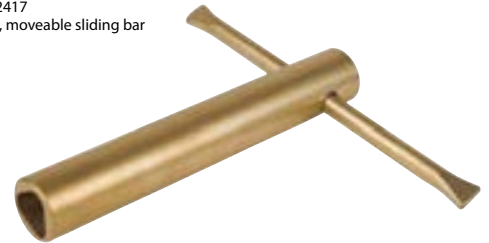

Code	No.	Size	(mm)	mm
2503824	GED0300004S	M4	95	80
2503786	GED0300005S	M5	110	100
2503778	GED0300006S	M6	115	170
2503751	GED0300008S	M8	125	280
2499622	GED0300010S	M10	140	390
2499614	GED0300012S	M12	160	700
2499606	GED0300016S	M16	180	980
2499592	GED0300020S	M20	200	2100
2499584	GED0300024S	M24	220	3100

GED0150

BARREL SPANNER UNIVERSAL

- ▀ For effortless opening of seized barrel fastenings

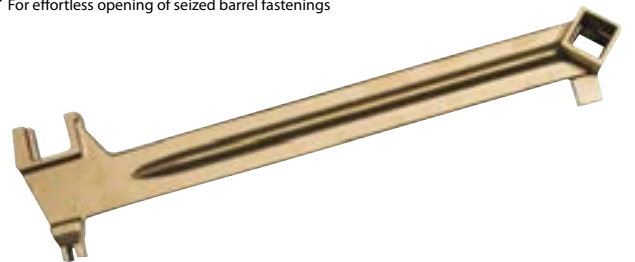

Code	No.	(mm)	mm
2519356	GED0150380S	380	1250

GED0150

UNIVERSAL WRENCH



Code	No.	(mm)	mm
2504081	GED0150381S	300	600

GED0150
SPECIAL ALL-PURPOSE SPANNER



Code No. (mm) 

2518457 **GED0150382S** 400 1700

GED0251
HEXAGONAL SOCKET SPANNER



Code	No.	O mm	(mm)	
2499703	GED0251055S	8	190	110
2499681	GED0251056S	9	200	135
2497344	GED0251057S	10	215	160
2497328	GED0251058S	11	230	210
2497301	GED0251059S	12	250	260
2497298	GED0251060S	13	265	350
2497271	GED0251061S	14	265	350
2497263	GED0251062S	15	280	400
2497255	GED0251063S	16	280	400
2497247	GED0251064S	17	300	450
2497239	GED0251065S	18	300	450
2497220	GED0251066S	19	325	650
2497212	GED0251067S	20	325	650
2497190	GED0251068S	21	350	830
2497182	GED0251069S	22	350	830
2497174	GED0251070S	23	380	1140
2497166	GED0251071S	24	380	1140
2497158	GED0251072S	25	415	1450
2497131	GED0251073S	26	415	1450
2497123	GED0251074S	27	415	1450
2497115	GED0251075S	28	450	1800
2497107	GED0251076S	29	450	1800
2497093	GED0251077S	30	450	1800
2497077	GED0251078S	32	485	2450
2497069	GED0251079S	33	485	2450
2497050	GED0251080S	34	485	2450
2497042	GED0251081S	35	530	3300
2497034	GED0251082S	36	530	3300
2497026	GED0251083S	37	530	3300
2497018	GED0251084S	38	530	3300
2496992	GED0251085S	41	580	4000
2496984	GED0251086S	42	580	4000
2496976	GED0251087S	46	635	4800
2496941	GED0251088S	47	635	4800
2496933	GED0251089S	50	320	4900
2496925	GED0251090S	52	320	4900
2496917	GED0251091S	54	340	6500
2496909	GED0251092S	55	340	6500
2496895	GED0251093S	56	340	6500
2496887	GED0251094S	58	360	8300
2496879	GED0251095S	60	360	8300
2496860	GED0251096S	63	360	8300
2496852	GED0251097S	65	380	10500
2496836	GED0251098S	67	380	10500
2496828	GED0251099S	70	380	10500
2496801	GED0251100S	71	380	10500
2496798	GED0251101S	75	400	14300
2496771	GED0251102S	77	400	14300
2496763	GED0251103S	80	400	14300
2496755	GED0251104S	82	400	14300
2496747	GED0251105S	85	425	19200
2496739	GED0251106S	88	425	19200
2496720	GED0251107S	90	425	19200
2496704	GED0251108S	94	455	26000
2496690	GED0251109S	95	455	26000
2492369	GED0251110S	100	455	26000

GED7240
SEWER LID HOOK



Code No. (mm) 

2507498 **GED7240003S** 500 770

GED7240
SEWER LID HOOK - REINFORCED TYPE



Code No. (mm) 

2507501 **GED7240002S** 700 1200

GED0251

TOMMY BAR FOR HEXAGONAL SOCKET SPANNER



Code	No.	Ø	↳mm↵	up to size mm	↕
2513714	GED02511115	6	150	10	40
2513692	GED02511125	8	190	12	75
2512084	GED02511135	10	190	16	90
2512076	GED02511145	10	250	22	185
2512068	GED02511155	12	315	27	310
2512041	GED02511165	16	400	34	600
2512033	GED02511175	16	500	38	920
2512025	GED02511185	20	630	47	1600
2512017	GED02511195	24	800	63	3100
2512009	GED02511205	24	1000	63	3850
2511991	GED02511215	30	1250	82	7500
2511975	GED02511225	36	1600	100	15000



GED0340

HEXAGONAL SOCKET SPANNER ANGLED



Code	No.	Ømm	↳mm↵	↕
2492229	GED03400085	8	175	100
2492210	GED03400095	9	185	120
2492202	GED03400105	10	195	140
2492180	GED03400115	11	205	180
2492172	GED03400125	12	220	220
2492164	GED03400135	13	240	280
2492156	GED03400145	14	240	280
2492148	GED03400155	15	250	300
2492121	GED03400165	16	250	300
2492113	GED03400175	17	270	320
2492105	GED03400185	18	270	320
2492091	GED03400195	19	290	530
2492083	GED03400205	20	290	530
2492067	GED03400215	21	310	680
2492059	GED03400225	22	310	680
2492040	GED03400235	23	335	830
2492032	GED03400245	24	335	830
2492024	GED03400255	25	365	1000
2492016	GED03400265	26	365	1000
2492008	GED03400275	27	365	1000
2491990	GED03400285	28	395	1300
2491982	GED03400295	29	395	1300
2491974	GED03400305	30	395	1300
2491958	GED03400325	32	425	1700
2491931	GED03400335	33	425	1700
2491923	GED03400345	34	425	1700
2491915	GED03400355	35	465	2800
2491907	GED03400365	36	465	2800
2491893	GED03400375	37	465	2800
2491885	GED03400385	38	465	2800
2491877	GED03400415	41	510	3600
2491869	GED03400425	42	510	3600
2491850	GED03400465	46	555	4000
2491834	GED03400475	47	555	4000
2491826	GED03400505	50	605	4800
2491818	GED03400525	52	605	4800
2491796	GED03400545	54	660	6400
2491788	GED03400555	55	660	6400
2491761	GED03400565	56	660	6400
2491753	GED03400585	58	730	8200
2491745	GED03400605	60	730	8200
2491737	GED03400635	63	730	8200
2491729	GED03400655	65	800	10400
2491702	GED03400675	67	800	10400
2491699	GED03400705	70	800	10400
2491680	GED03400715	71	800	10400
2491672	GED03400755	75	880	14100
2491664	GED03400775	77	880	14100
2491656	GED03400805	80	880	14100
2491648	GED03400825	82	880	14100

GED0340

HEXAGONAL SOCKET SPANNER DOUBLE-SIDED

► For use with open-ended spanner or tommy bar



Code	No.	Ø mm	l mm	l ₁ mm	l ₂ mm
2496674	GED0340083S	7 x 8	95		50
2491621	GED0340084S	9 x 10	105		70
2491613	GED0340085S	10 x 11	120		85
2491605	GED0340086S	12 x 14	135		160
2524163	GED0340087S	14 x 17	150		205
2524155	GED0340088S	17 x 19	160		280
2524147	GED0340089S	19 x 22	170		335
2524139	GED0340090S	20 x 22	170		355
2524120	GED0340091S	24 x 26	180		480
2524112	GED0340092S	24 x 27	190		530
2524104	GED0340093S	27 x 32	200		870
2524090	GED0340094S	30 x 32	210		890
2524082	GED0340095S	30 x 36	220		1080
2524074	GED0340096S	36 x 41	230		1700

GED0340

TOMMY BAR FOR HEXAGONAL SOCKET SPANNER



Code	No.	Ø	l mm	up to size mm	l ₁ mm
2513005	GED0340097S	5	110	7 x 8	15
2510375	GED0340098S	6	150	10 x 11	40
2508427	GED0340099S	10	220	14 x 17	120
2508419	GED0340100S	12	300	20 x 22	300
2508400	GED0340101S	15	390	24 x 27	480
2508397	GED0340102S	16	500	36 x 41	750



GED0340

HEXAGONAL SOCKET WRENCH WITH FIRM SLIDING BAR

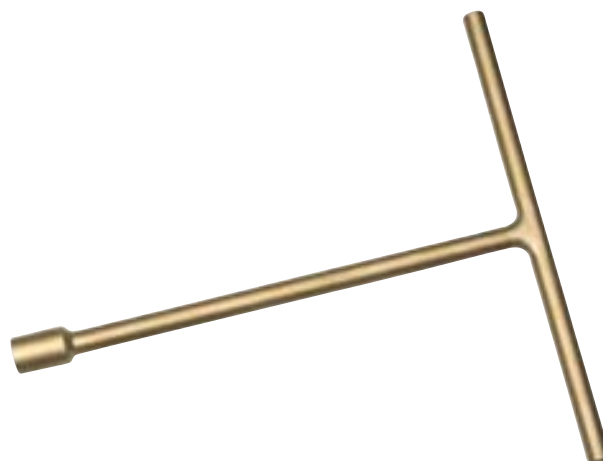

Code	No.	Ø mm	l mm	l ₁ mm	l ₂ mm
2516055	GED0340108S	8	196		140
2516047	GED0340109S	9	209		165
2507595	GED0340110S	10	223		190
2507463	GED0340111S	11	240		260
2507331	GED0340112S	12	256		310
2507226	GED0340113S	13	275		410
2507099	GED0340114S	14	275		410
2506963	GED0340115S	15	292		455
2506858	GED0340116S	16	292		455
2506734	GED0340117S	17	314		555
2506602	GED0340118S	18	314		555
2506483	GED0340119S	19	339		785
2506378	GED0340120S	20	339		785
2506254	GED0340121S	21	376		1050
2506114	GED0340122S	22	376		1050
2505991	GED0340123S	23	393		1240
2505886	GED0340124S	24	393		1240
2505762	GED0340125S	25	431		1700
2505630	GED0340126S	26	431		1700
2505517	GED0340127S	27	431		1700
2505398	GED0340128S	28	464		2100
2505274	GED0340129S	29	464		2100
2505150	GED0340130S	30	464		2100
2505029	GED0340132S	32	506		2750
2504898	GED0340133S	33	506		2750
2504774	GED0340134S	34	506		2750
2504650	GED0340135S	35	550		4000
2504529	GED0340136S	36	550		4000
2504405	GED0340137S	37	550		4000
2504294	GED0340138S	38	550		4000
2504170	GED0340141S	41	600		5400
2504049	GED0340142S	42	600		5400
2503921	GED0340146S	46	655		6000
2503816	GED0340147S	47	655		6000
2503670	GED0340150S	50	345		6300
2503549	GED0340152S	52	345		6300
2503425	GED0340154S	54	365		8000
2503301	GED0340155S	55	365		8000
2503182	GED0340156S	56	365		8000
2503069	GED0340158S	58	390		10500
2502933	GED0340160S	60	390		10500
2502828	GED0340163S	63	390		10500
2502690	GED0340165S	65	410		14000
2502577	GED0340167S	67	410		14000
2502437	GED0340170S	70	410		14000
2502313	GED0340171S	71	410		14000
2502208	GED0340175S	75	430		19000
2502089	GED0340177S	77	430		19000
2501953	GED0340180S	80	430		19000
2501848	GED0340182S	82	430		19000

GED0341

NUT DRIVER WITH HANDLE



mm

Code	No.	Ø mm	l mm	l _h mm
2496666	GED0341035C	3,5	175	55
2496658	GED0341045C	4,5	180	55
2503735	GED0341050C	5	180	60
2496631	GED0341055C	5,5	185	60
2503727	GED0341060C	6	190	65
2496623	GED0341065C	6,5	190	65
2503719	GED0341070C	7	190	80
2496615	GED0341075C	7,5	200	80
2503700	GED0341080C	8	200	100
2503697	GED0341090C	9	210	100
2499568	GED0341010C	10	210	115
2499541	GED0341011C	11	220	115
2499533	GED0341012C	12	220	130
2499517	GED0341013C	13	230	170
2499509	GED0341014C	14	230	210
2499495	GED0341015S	15	240	210
2499487	GED0341016S	16	240	235
2499479	GED0341017S	17	250	235

GED0341

NUT DRIVER WITH HANDLE INCH



"AF

Code	No.	Ø "AF	l mm	l _h mm
2499460	GED0341091C	1/8	175	55
2496607	GED0341092C	5/32	180	55
2496585	GED0341093C	3/16	185	60
2496577	GED0341094C	7/32	190	65
2499452	GED0341095C	1/4	190	80
2496569	GED0341096C	5/16	210	100
2499444	GED0341097C	3/8	220	115
2496550	GED0341098C	7/16	230	170
2499436	GED0341099C	1/2	230	210
2496542	GED0341100S	9/16	240	235
2499428	GED0341101S	5/8	250	235
2524058	GED0341102S	11/16	250	240

GED01376

PRONGED WRENCH WITHOUT TOMMY BAR

Angled open-end spanner for work in confined spaces



Code	No.	Ø mm	l mm	l _h mm
2500043	GED0137600S	13	160	100
2500035	GED0137601S	14	160	100
2499576	GED0137602S	15	200	170
2500027	GED0137603S	16	200	170
2500019	GED0137604S	17	200	170
2499991	GED0137605S	18	200	190
2499983	GED0137606S	19	200	220
2499975	GED0137607S	20	200	250
2499967	GED0137608S	21	200	260
2499959	GED0137609S	22	200	300
2499940	GED0137610S	23	200	350
2499932	GED0137611S	24	250	400
2499924	GED0137612S	25	250	400
2499916	GED0137613S	26	250	450
2499908	GED0137614S	27	250	450
2499886	GED0137615S	28	250	500
2499878	GED0137616S	29	250	550
2499851	GED0137617S	30	250	600
2499843	GED0137618S	32	250	650
2499835	GED0137619S	36	250	700
2499827	GED0137620S	41	315	1150
2499819	GED0137621S	46	315	1230
2499800	GED0137622S	50	315	1500

GED01376

TOMMY BAR FOR CROWFOOT SPANNERS



Code	No.	Ø	l mm	for size mm	l _h mm
2516292	GED0137623S	8	160	13 - 15	70
2516284	GED0137624S	10	200	16 - 18	130
2516276	GED0137625S	12	200	19 - 22	220
2509059	GED0137626S	14	250	23 - 27	400
2508931	GED0137627S	16	250	28 - 32	600
2508826	GED0137628S	18	315	36 - 41	1000
2508699	GED0137629S	20	315	46 - 50	1600



GED01376

CROWFOOT SPANNER, OPEN-END FORM, SQUARE 1/2"



Code	No.	□"	○mm	↳
2519658	GED01376305	1/2	13	50
2519631	GED01376315	1/2	14	50
2519623	GED01376325	1/2	15	80
2519615	GED01376335	1/2	16	80
2519607	GED01376345	1/2	17	80
2519593	GED01376355	1/2	18	110
2519585	GED01376365	1/2	19	120
2519577	GED01376375	1/2	20	130
2519569	GED01376385	1/2	21	150
2519542	GED01376395	1/2	22	170
2519534	GED01376405	1/2	23	200
2519526	GED01376415	1/2	24	200
2519518	GED01376425	1/2	25	220
2519496	GED01376435	1/2	26	220
2519488	GED01376445	1/2	27	250
2519461	GED01376455	1/2	28	270
2519453	GED01376465	1/2	29	300
2519445	GED01376475	1/2	30	320
2519437	GED01376485	1/2	32	350
2519410	GED01376495	1/2	36	570
2519402	GED01376505	1/2	41	620
2519399	GED01376515	1/2	46	750
2519380	GED01376525	1/2	50	800

GED01376

SPECIAL EXTENDER FOR 1/2" CROWFOOT SPANNER



Code	No.	■"	□"	↳mm	↳
2519372	GED01376535	1/2	1/2	150	200
2519364	GED01376545	1/2	1/2	250	400

GED01374

CONSTRUCTION RATCHET, HEXAGONAL, WITH "RAT-TAIL" HANDLE



Code	No.	○mm	↳mm	↳
2493136	GED01374005	17	230	620
2493128	GED01374015	19	240	650
2493101	GED01374025	21	250	830
2493098	GED01374035	22	260	830
2493071	GED01374045	24	270	1020
2493063	GED01374055	26	280	1050
2493047	GED01374065	27	285	1100
2493039	GED01374075	30	300	1320
2493020	GED01374085	32	315	1425
2493012	GED01374095	35	325	1630
2493004	GED01374105	36	330	1670
2492997	GED01374115	41	330	1950

GED01374

FRICITION RATCHET WITH BI-HEXAGON RING



Code	No.	○mm	↳mm	↳
2492989	GED0137416C	9	150	125
2519860	GED0137402C	11	150	125
2519836	GED0137405C	13	155	160
2519763	GED0137409C	14	155	160
2519887	GED0137400C	17	200	260
2519879	GED0137401C	19	200	260
2519852	GED0137403C	22	220	340
2519844	GED0137404C	24	220	340
2519828	GED0137406C	27	245	560
2519801	GED0137407C	30	280	840
2519771	GED0137408C	32	280	840
2519755	GED0137410C	36	290	1180
2519747	GED0137411C	41	295	1230
2519739	GED0137412C	46	360	2060
2519720	GED0137413C	50	360	2230
2519712	GED0137414C	55	440	2900
2519704	GED0137415C	60	440	2900

SOCKET SETS

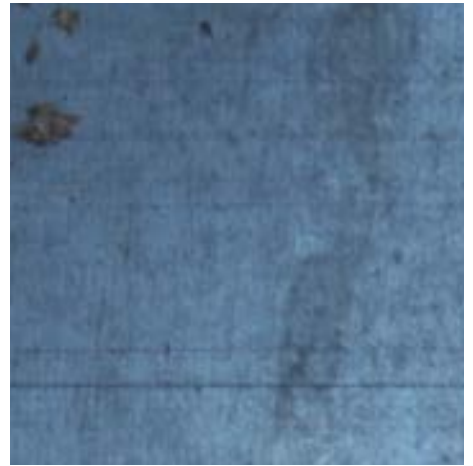

NON
SPARKING

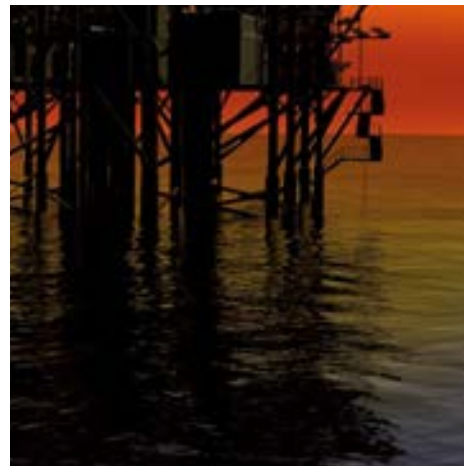

S Accessories

SOCKET SETS AND ACCESSORIES NON-SPARKING

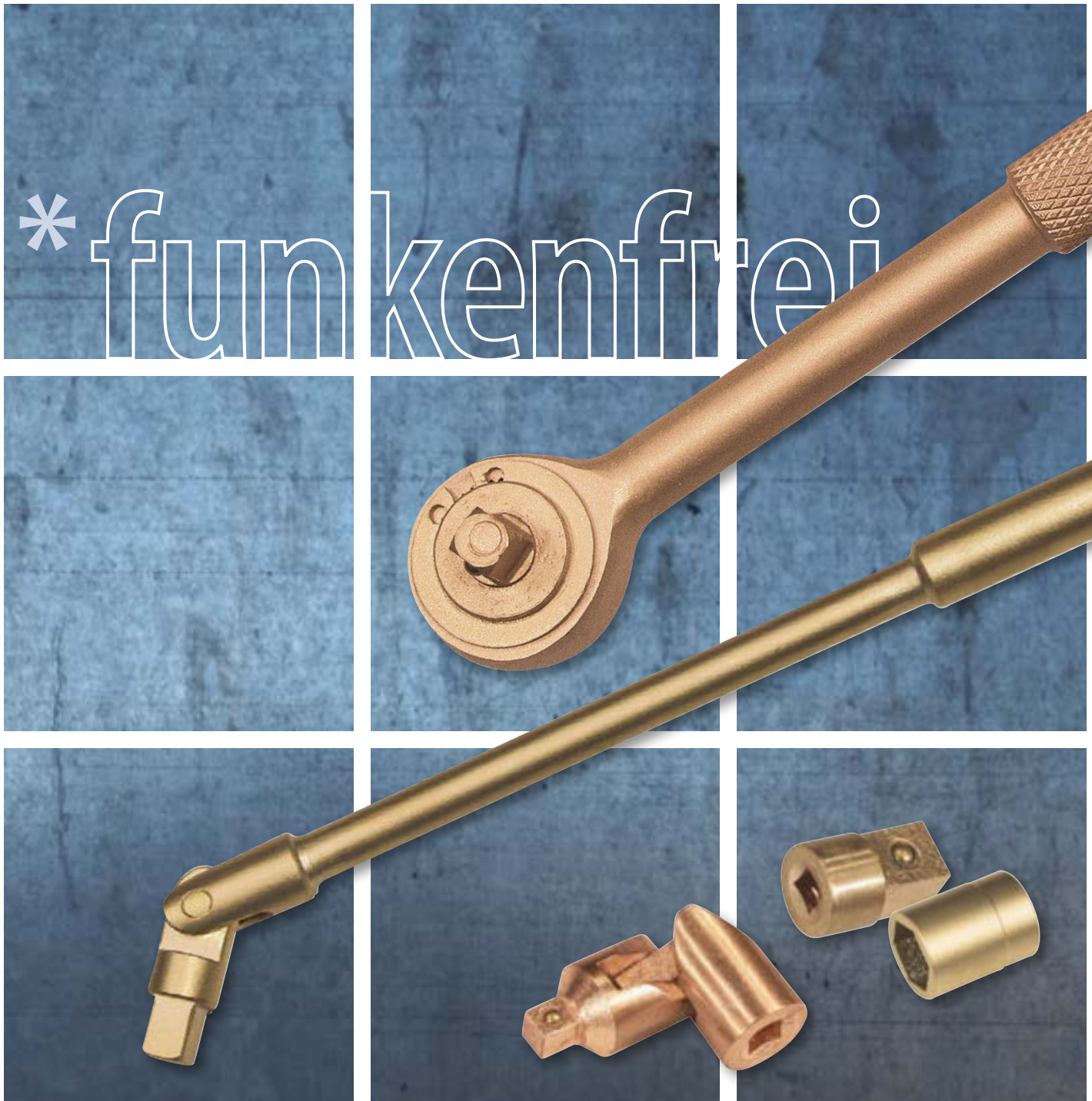

SOCKET SETS AND ACCESSORIES

1/4" SQUARE DRIVE

GED035

SOCKET 1/4" HEXAGON
 ▽ Hand-operated



6.3
 1/4"
 mm

Code	No.	□"	□	Ø mm	↳ mm	↳ mm
2496534	GED0350414C	1/4	6.3	4.0	25	13
2517752	GED0354514C	1/4	6.3	4.5	25	14
2496526	GED0350514C	1/4	6.3	5.0	25	14
2517698	GED0355514C	1/4	6.3	5.5	25	14
2496496	GED0350614C	1/4	6.3	6.0	25	12
2496445	GED0350714C	1/4	6.3	7.0	25	14
2496429	GED0350814C	1/4	6.3	8.0	25	17
2496402	GED0350914C	1/4	6.3	9.0	25	19
2523787	GED0351014C	1/4	6.3	10.0	25	20
2523655	GED0351114C	1/4	6.3	11.0	25	24
2523515	GED0351214C	1/4	6.3	12.0	27	29
2523493	GED0351314C	1/4	6.3	13.0	27	28
2523477	GED0351414C	1/4	6.3	14.0	27	30

GED0360

REVERSIBLE RATCHET 1/4"



6.3
 1/4"

Code	No.	□"	□	↳ mm	↳ mm
2513676	GED0360014C	1/4	6.3	150	165

GED0360

RATCHET HANDLE WITH COUPLER 1/4"



6.3
 1/4"

Code	No.	□"	□	↳ mm	↳ mm
2511932	GED0360141C	1/4	6.3	150	320

GED0421

EXTENSION 1/4"
 ▽ For hand-operated sockets



6.3
 1/4"

Code	No.	□"	□	↳ mm	↳ mm
2507862	GED0421430C	1/4	6.3	55	20
2506297	GED0421410C	1/4	6.3	100	60
2506289	GED0421420C	1/4	6.3	200	100

GED0410

SWIVEL HANDLE 1/4"
 ▽ For hand-operated sockets

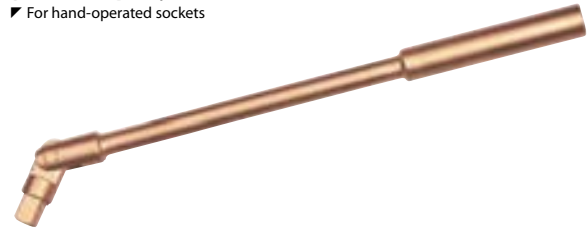

6.3
 1/4"

Code	No.	□"	□	↳ mm	↳ mm
2507919	GED0410014C	1/4	6.3	165	160
2507900	GED0410015C	1/4	6.3	215	350

GED0400

SLIDING BAR 1/4"
 ▽ For hand-operated sockets

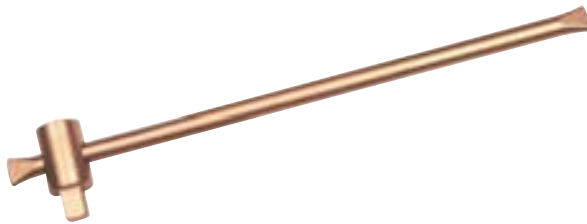

6.3
 1/4"

Code	No.	□"	□	↳ mm	↳ mm
2511916	GED0400014C	1/4	6.3	200	160

GED0400

DRIVING HANDLE 1/4"
 ▽ For hand-operated sockets



6.3
 1/4"

Code	No.	□"	□	↳ mm	↳ mm
2511908	GED0400015C	1/4	6.3	140	65

GED0400

CONVERTOR 1/4" TO 1/2"
 ▽ For hand-operated sockets



6.3
 1/4"
 12.5
 1/2"

Code	No.	□"	□	□"	□	↳ mm	↳ mm
2522896	GED0400016C	1/4	6.3	1/2	12.5	30	40

GED0400
COUPLER 1/4"
 For hand-operated sockets

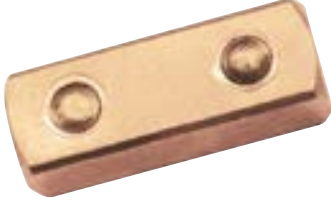

6.3
1/4"

Code	No.	□"	□	↳mm↳	↳mm↳
2503298	GED0400017C	1/4	6.3	25	8

GED0400
UNIVERSAL JOINT 1/4"
 For hand-operated sockets



6.3
1/4"

Code	No.	□"	□	↳mm↳	↳mm↳
2514826	GED0400018C	1/4	6.3	1/4	6.3

GED0430
SOCKET SET 1/4" 16 pieces
 In plastic case, 240x180x60 mm



6.3
1/4"

Code	No.	Contents	↳mm↳
2503255	GED0430001C	1 Reversible ratchet 1/4" 1 Extension 1/4" 100 mm 1 socket 1/4" each 4 4,5 5 5,5 6 7 8 9 10 11 12 13 14 mm	875

1/2" SQUARE DRIVE

GED035
SOCKET 1/2" HEXAGON
 Hand-operated



12.5
1/2"
mm

Code	No.	□"	□	↳mm↳	↳mm↳	↳mm↳
2496518	GED0350612S	1/2	12.5	6	40	50
2496488	GED0350712S	1/2	12.5	7	40	55
2496437	GED0350812S	1/2	12.5	8	40	50
2496410	GED0350912S	1/2	12.5	9	40	50
2523795	GED0351012S	1/2	12.5	10	40	50
2523671	GED0351112S	1/2	12.5	11	40	50
2523523	GED0351212S	1/2	12.5	12	40	50
2523507	GED0351312S	1/2	12.5	13	40	50
2523485	GED0351412S	1/2	12.5	14	40	55
2523469	GED0351512S	1/2	12.5	15	40	55
2523442	GED0351612S	1/2	12.5	16	40	60
2523434	GED0351712S	1/2	12.5	17	40	65
2523426	GED0351812S	1/2	12.5	18	40	75
2523396	GED0351912S	1/2	12.5	19	40	85
2523361	GED0352012S	1/2	12.5	20	40	95
2523353	GED0352112S	1/2	12.5	21	40	100
2523337	GED0352212S	1/2	12.5	22	40	110
2523302	GED0352312S	1/2	12.5	23	40	120
2517965	GED0352412S	1/2	12.5	24	40	125
2523280	GED0352512S	1/2	12.5	25	40	130
2523264	GED0352612S	1/2	12.5	26	40	145
2523248	GED0352712S	1/2	12.5	27	40	150
2523213	GED0352812S	1/2	12.5	28	40	175
2523183	GED0352912S	1/2	12.5	29	40	185
2523167	GED0353012S	1/2	12.5	30	40	195
2523140	GED0353212S	1/2	12.5	32	42	240
2523116	GED0353412S	1/2	12.5	34	50	300
2523078	GED0353612S	1/2	12.5	36	50	380
2523019	GED0354112S	1/2	12.5	41	50	450



GED035

SOCKET 1/2" HEXAGON, LONG

Hand-operated



Code	No.	□"	□	○mm	↳mm↳	↳
2524007	GED0350001S	1/2	12.5	10	77	110
2523981	GED0350002S	1/2	12.5	12	77	135
2523973	GED0350003S	1/2	12.5	13	77	105
2523965	GED0350004S	1/2	12.5	14	77	110
2523957	GED0350005S	1/2	12.5	15	77	120
2523949	GED0350006S	1/2	12.5	16	77	125
2523922	GED0350007S	1/2	12.5	17	77	140
2523914	GED0350008S	1/2	12.5	18	82	145
2523906	GED0350009S	1/2	12.5	19	82	180
2523892	GED0350010S	1/2	12.5	21	82	205
2523884	GED0350011S	1/2	12.5	22	82	210
2523876	GED0350012S	1/2	12.5	24	82	250
2523868	GED0350013S	1/2	12.5	27	82	285
2523841	GED0350014S	1/2	12.5	30	82	345
2523833	GED0350015S	1/2	12.5	32	82	375
2523825	GED0350016S	1/2	12.5	34	82	415
2523809	GED0350025S	1/2	12.5	36	82	425

GED035

SOCKET 1/2" HEXAGON INCH

Hand-operated



Code	No.	□"	□	○"AF	↳mm↳	↳
2518260	GED0350100S	1/2	12.5	1/4	40	50
2516039	GED0350101S	1/2	12.5	5/16	40	50
2501600	GED0350102S	1/2	12.5	11/32	40	50
2518252	GED0350103S	1/2	12.5	3/8	40	50
2501473	GED0350104S	1/2	12.5	13/32	40	50
2516020	GED0350105S	1/2	12.5	7/16	40	50
2518244	GED0350106S	1/2	12.5	1/2	40	50
2516004	GED0350107S	1/2	12.5	9/16	40	55
2501368	GED0350108S	1/2	12.5	19/32	40	55
2518236	GED0350109S	1/2	12.5	5/8	40	60
2501236	GED0350110S	1/2	12.5	11/16	40	65
2518201	GED0350111S	1/2	12.5	3/4	40	85
2501104	GED0350112S	1/2	12.5	25/32	40	95
2500973	GED0350113S	1/2	12.5	13/16	40	95
2518198	GED0350114S	1/2	12.5	7/8	40	110
2500868	GED0350115S	1/2	12.5	15/16	40	120
2515997	GED0350116S	1/2	12.5	1	40	130
2520273	GED0350117S	1/2	12.5	1.1/16	40	150
2500744	GED0350118S	1/2	12.5	1.1/8	40	175
2520168	GED0350119S	1/2	12.5	1.3/16	40	195
2500612	GED0350120S	1/2	12.5	1.1/4	42	240

GED0360

REVERSIBLE RATCHET 1/2"

For hand-operated sockets



Code	No.	□"	□	↳mm↳	↳
2513684	GED0360012C	1/2	12.5	250	590

GED0360

RATCHET HANDLE WITH COUPLER 1/2"

For hand-operated sockets



Code	No.	□"	□	↳mm↳	↳
2511940	GED0360121C	1/2	12.5	250	430

GED042

EXTENSION 1/2"

For hand-operated sockets



Code	No.	□"	□	↳mm↳	↳
2506335	GED0420002S	1/2	12.5	100	180
2506270	GED0421434S	1/2	12.5	200	315
2506319	GED0420121S	1/2	12.5	250	360

GED0410

SWIVEL HANDLE 1/2"

For hand-operated sockets



Code	No.	□"	□	↳mm↳	↳
2507935	GED0410012S	1/2	12.5	215	350
2507927	GED0410013S	1/2	12.5	250	560
2507897	GED0410016S	1/2	12.5	300	920
2507870	GED0410101S	1/2	12.5	380	590

GED0400
SLIDING T BAR 1/2"
 For hand-operated sockets

12,5
1/2



Code	No.	"	"	mm	
2511886	GED04001145	1/2	12.5	250	450
2511924	GED04000125	1/2	12.5	320	550

GED0400
L-HANDLE 1/2"
 For hand-operated sockets

12,5
1/2



Code	No.	"	"	mm	
2508044	GED04001205	1/2	12.5	220	260
2508036	GED04001215	1/2	12.5	260	400

GED0400
CONVERTOR 1/2" TO 3/4"
 For hand-operated sockets

12,5
1/2
20
3/4



Code	No.	"	"	"	"	mm	
2522888	GED04001165	1/2	12.5	3/4	20.0	22	120

GED0400
SPEED BRACE 1/2"
 For hand-operated sockets

12,5
1/2



Code	No.	"	"	mm	
2514176	GED04001225	1/2	12.5	410	615

GED0400
REDUCER 1/2" TO 1/4"
 For hand-operated sockets

12,5
1/2
6,3
1/4



Code	No.	"	"	"	"	mm	
2503271	GED04001195	1/2	12.5	1/4	6.3	40	60

GED0370
T-HANDLE 1/2"
 For hand-operated sockets

12,5
1/2



Code	No.	"	"	mm	
2499231	GED03700125	1/2	12.5	245	500

GED0400
COUPLER 1/2"
 For hand-operated sockets

12,5
1/2



Code	No.	"	"	mm	
2506408	GED04001175	1/2	12.5	36.5	46

GED0400
UNIVERSAL JOINT 1/2"
 For hand-operated sockets

12,5
1/2



Code	No.	"	"	mm	
2514788	GED04001185	1/2	12.5	70	135

GED0400

SWIVEL HANDLE WITH SLIDING T 1/2"

For hand-operated sockets

12.5
1/2"



Code	No.	□"	□	mm	mm	mm
2522861	GED04001235	1/2	12.5	460	755	

GED0430

SOCKET SET 1/2"

In plastic case

12.5
1/2"



Code	No.	Contents	pieces	mm
2503204	GED04300055	1 Reversible ratchet 1/2" 1 Extension 1/2" 100 mm 1 socket 1/2" each 10 11 13 14 15 17 19 22 24 mm	12	5300
2503212	GED04300045	1 Reversible ratchet 1/2" 1 socket 1/2" each 10 11 12 13 14 15 16 17 18 19 20 21 22 23 24 25 26 27 28 29 30 32 mm	24	4100
2503247	GED04300015	1 Reversible ratchet 1/2" 1 Extension 1/2" 250 mm 1 socket 1/2" each 10 11 12 13 14 15 16 17 18 19 20 21 22 23 24 25 26 27 28 29 30 32 mm	25	2000
2503239	GED04300025	1 Reversible ratchet 1/2" 1 Extension 1/2" 150 mm 1 Sliding T bar 1/2" 320 mm 1 Swivel handle 1/2" 380 mm 1 socket 1/2" each 10 11 12 13 14 15 16 17 18 19 20 21 22 23 24 25 26 27 28 29 30 32 mm	27	4100

GED0440

SCREWDRIVER BIT SOCKET 1/2" for slotted head screws

Hand-operated

12.5
1/2"



Code	No.	□"	□	mm	mm	mm
2499215	GED04400005	1/2	12.5	4	60	140
2499207	GED04400015	1/2	12.5	6	60	140
2499193	GED04400025	1/2	12.5	8	60	140
2496062	GED04400035	1/2	12.5	10	60	140

GED0440

SCREWDRIVER BIT SOCKET 1/2" for cross-slotted head screws PH

Hand-operated

12.5
1/2"



Code	No.	□"	□	PH	mm	mm
2522810	GED04400045	1/2	12.5	1	60	140
2522802	GED04400055	1/2	12.5	2	60	140
2522799	GED04400065	1/2	12.5	3	60	140
2522780	GED04400075	1/2	12.5	4	60	140

GED0440

SCREWDRIVER BIT SOCKET 1/2" for in-hex screws

Hand-operated

With welded-in hexagon pin

12.5
1/2"

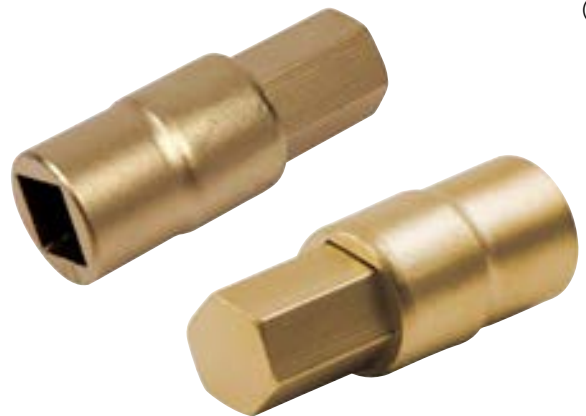

Code	No.	□"	□	mm	mm	mm
2499185	GED04400085	1/2	12.5	4	60	65
2499177	GED04400095	1/2	12.5	5	60	70
2499150	GED04400105	1/2	12.5	6	60	70
2499142	GED04400115	1/2	12.5	7	60	75
2499134	GED04400125	1/2	12.5	8	60	80
2499126	GED04400135	1/2	12.5	9	60	85
2496054	GED04400145	1/2	12.5	10	60	95
2496046	GED04400155	1/2	12.5	12	60	115
2496038	GED04400165	1/2	12.5	14	60	145
2496011	GED04400175	1/2	12.5	17	60	205
2496003	GED04400185	1/2	12.5	19	60	230

GED0440

SCREWDRIVER BIT SOCKET 1/2", LONG for in-hex screws

- ▶ Hand-operated
- ▶ With welded-in hexagon pin



Code	No.	□"	□	● mm	↳ mm	↳ mm
2522772	GED04400285	1/2	12.5	5	90	90
2517574	GED04400295	1/2	12.5	5	180	125
2522764	GED04400305	1/2	12.5	6	90	80
2517566	GED04400315	1/2	12.5	6	140	120
2517558	GED04400325	1/2	12.5	6	160	135
2517531	GED04400335	1/2	12.5	7	100	90
2522756	GED04400345	1/2	12.5	8	90	90
2517523	GED04400355	1/2	12.5	8	120	105
2517515	GED04400365	1/2	12.5	10	140	150
2517507	GED04400375	1/2	12.5	12	140	190
2517493	GED04400385	1/2	12.5	14	140	250

GED0440

SCREWDRIVER BIT SOCKET SET 1/2"

- ▶ Hand-operated
- ▶ With welded-in hexagon pin
- ▶ In wooden case with non-sparking hinge



Code	No.	Contents	pieces	↳ mm
2498189	GED04400395	1 socket 1/2" each 5 6 7 8 9 10 12 14 17 mm	10	1240
2498057	GED04400405	1 Reversible ratchet 1/2" 1 Extension 1/2", 250 mm 1 socket 1/2" each 5 6 7 8 9 10 12 14 17 mm	12	2990
2497948	GED04400415	1 socket 1/2" each 5 6 7 8 9 10 12 14 17 mm 1 socket 1/2" each 5-90 6-90 8-90 10-140 12-140 14-140 mm	16	2790

3/4" SQUARE DRIVE

GED035

SOCKET 3/4" HEXAGON

- ▶ Hand-operated

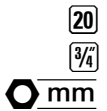

Code	No.	□"	□	○ mm	↳ mm	↳ mm
2523418	GED0351834S	3/4	20	18	60	180
2523388	GED0351934S	3/4	20	19	60	180
2523345	GED0352134S	3/4	20	21	60	180
2523310	GED0352234S	3/4	20	22	60	180
2523299	GED0352434S	3/4	20	24	55	350
2523272	GED0352534S	3/4	20	25	55	350
2523256	GED0352634S	3/4	20	26	50	330
2523221	GED0352734S	3/4	20	27	50	300
2523191	GED0352834S	3/4	20	28	50	300
2523175	GED0352934S	3/4	20	29	50	300
2523159	GED0353034S	3/4	20	30	50	310
2523132	GED0353234S	3/4	20	32	60	375
2523124	GED0353334S	3/4	20	33	60	450
2523108	GED0353434S	3/4	20	34	60	465
2523086	GED0353534S	3/4	20	35	55	400
2523051	GED0353634S	3/4	20	36	60	430
2523043	GED0353834S	3/4	20	38	60	490
2523000	GED0354134S	3/4	20	41	65	560
2522993	GED0354234S	3/4	20	42	65	600
2522985	GED0354634S	3/4	20	46	65	655
2522950	GED0355034S	3/4	20	50	70	785
2522942	GED0355534S	3/4	20	55	70	900
2522934	GED0355834S	3/4	20	58	60	950
2522926	GED0356034S	3/4	20	60	70	1290

GED035

SOCKET 3/4" HEXAGON INCH

- ▶ Hand-operated



Code	No.	□"	□	○ AF	↳ mm	↳ mm
2517663	GED0356035S	3/4	20	7/8	60	180
2499894	GED0356036S	3/4	20	15/16	55	350
2515865	GED0356037S	3/4	20	1	55	350
2520044	GED0356038S	3/4	20	1.1/16	50	300
2499770	GED0356039S	3/4	20	1.1/8	50	300
2499649	GED0356040S	3/4	20	1.1/4	60	375
2519917	GED0356041S	3/4	20	1.5/16	60	400
2499525	GED0356042S	3/4	20	1.3/8	55	400
2519798	GED0356043S	3/4	20	1.7/16	60	430
2501724	GED0356044S	3/4	20	1.1/2	60	490
2519674	GED0356045S	3/4	20	1.9/16	60	490
2499401	GED0356046S	3/4	20	1.5/8	65	560
2513579	GED0356047S	3/4	20	1.11/16	65	560
2499282	GED0356048S	3/4	20	1.3/4	65	600
2512343	GED0356049S	3/4	20	1.13/16	65	655
2499169	GED0356050S	3/4	20	1.7/8	65	655
2515857	GED0356051S	3/4	20	2	70	700

GED0360

REVERSIBLE RATCHET 3/4"
 ▽ For hand-operated sockets

20
 3/4"



Code	No.	□"	■	↳mm↳	↕
2499266	GED0360034C	3/4	20	300	1900

GED0360

RATCHET HANDLE WITH COUPLER 3/4"
 ▽ For hand-operated sockets

20
 3/4"



Code	No.	□"	■	↳mm↳	↕
2522918	GED0360134C	3/4	20	500	1800

GED04

EXTENSION 3/4"
 ▽ For hand-operated sockets

20
 3/4"



Code	No.	□"	■	↳mm↳	↕
2506394	GED0400124S	3/4	20	100	350
2506327	GED0420003S	3/4	20	250	700
2506300	GED0420134S	3/4	20	380	1670
2506386	GED0400126S	3/4	20	430	1500

GED0410

SWIVEL HANDLE 3/4"
 ▽ For hand-operated sockets

20
 3/4"



Code	No.	□"	■	↳mm↳	↕
2507889	GED0410034S	3/4	20	380	755
2508028	GED0400128S	3/4	20	460	1300
2508001	GED0400129S	3/4	20	550	1950

GED0400

SLIDING T BAR 3/4"
 ▽ For hand-operated sockets

20
 3/4"



Code	No.	□"	■	↳mm↳	↕
2511851	GED0400130S	3/4	20	260	600
2511894	GED0400034S	3/4	20	500	1480

GED0400

CONVERTOR 3/4" TO 1"
 ▽ For hand-operated sockets

20
 3/4"
 25
 1"



Code	No.	□"	□	■"	■	↳mm↳	↕
2522853	GED0400131S	3/4	20	1	25.0	61	325

GED0400

REDUCER 3/4" TO 1/2"
 ▽ For hand-operated sockets

20
 3/4"
 12.5
 1/2"



Code	No.	□"	□	■"	■	↳mm↳	↕
2503263	GED0400135S	3/4	20	1/2	12.5	57	165

GED0400

COUPLER 3/4"
 ▽ For hand-operated sockets

20
 3/4"



Code	No.	□"	■	↳mm↳	↕
2506351	GED0400132S	3/4	20	51.5	135

GED0400

UNIVERSAL JOINT 3/4"
 ▽ For hand-operated sockets

20
 3/4"



Code	No.	□"	■	↳mm↳	↕
2507994	GED0400133S	3/4	20	85	550
2506343	GED0400134S	3/4	20	106	570

GED0400
L-HANDLE 3/4"
 ▸ For hand-operated sockets



20
3/4"

Code	No.	□"	■	↳mm	↕
2507986	GED04001365	3/4	20	300	800

GED0400
SPEED BRACE 3/4"
 ▸ For hand-operated sockets

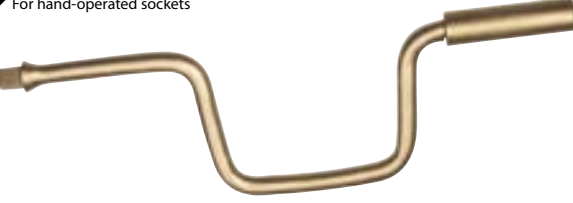

20
3/4"

Code	No.	□"	■	↳mm	↕
2514168	GED04001375	3/4	20	380	1250

GED0370
T-HANDLE 3/4"
 ▸ For hand-operated sockets

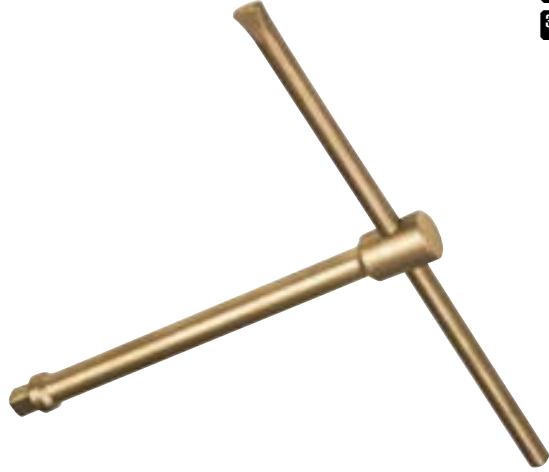

20
3/4"

Code	No.	□"	■	↳mm	↕
2499223	GED03700345	3/4	20	260	850

GED0400
SWIVEL HANDLE WITH SLIDING T 3/4"
 ▸ For hand-operated sockets

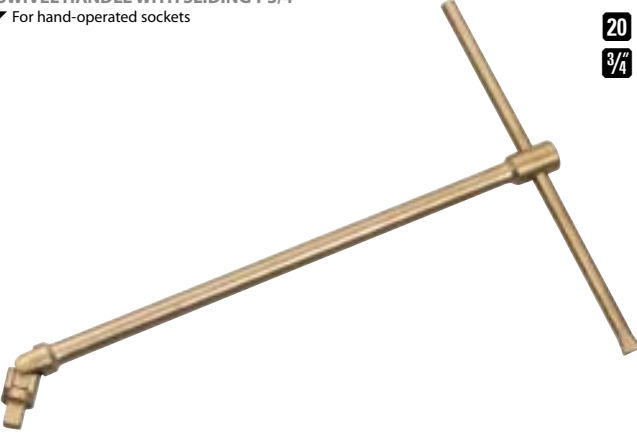

20
3/4"

Code	No.	□"	■	↳mm	↕
2522845	GED04001385	3/4	20	560	1200

GED0430
SOCKET SET 3/4" 12 pieces
 ▸ In wooden case with non-sparking hinge



20
3/4"

Code	No.	Contents	↕
2503220	GED04300035	1 Reversible ratchet 3/4" 1 Extension 3/4" 380 mm 1 Sliding T bar 3/4" 500 mm 1 Swivel handle 3/4" 380 mm 1 socket 3/4" each 36 38 41 46 50 55 60 mm	12700

GED0440
SCREWDRIVER BIT SOCKET 3/4" for in-hex screws
 ▸ Hand-operated
 ▸ With welded-in hexagon pin



20
3/4"

Code	No.	□"	□	●mm	↳mm	↕
2517485	GED04400435	3/4	20	14	80	350
2517469	GED04400455	3/4	20	17	80	390
2517450	GED04400465	3/4	20	19	80	435
2517442	GED04400475	3/4	20	22	80	480
2517434	GED04401045	3/4	20	24	80	520
2517426	GED04401055	3/4	20	27	80	550
2517418	GED04401075	3/4	20	30	80	570
2517396	GED04401085	3/4	20	32	80	590
2517388	GED04401095	3/4	20	36	80	620
2517361	GED04401105	3/4	20	41	90	720
2517353	GED04401115	3/4	20	46	90	820



1" SQUARE DRIVE

GED035

SOCKET 1" HEXAGON
 ▽ Hand-operated



25
 1"
 mm

Code	No.	□"	□	Ø mm	l mm	l ₂
2517949	GED0353201S	1	25	32	60	510
2517930	GED0353601S	1	25	36	65	550
2517779	GED0354101S	1	25	41	70	730
2517760	GED0354201S	1	25	42	65	710
2517744	GED0354601S	1	25	46	65	710
2517736	GED0355001S	1	25	50	70	930
2517701	GED0355501S	1	25	55	75	1130
2517671	GED0356001S	1	25	60	75	1350
2517655	GED0356501S	1	25	65	75	1500
2517647	GED0357001S	1	25	70	85	1750
2517639	GED0357501S	1	25	75	85	2300
2517620	GED0358001S	1	25	80	85	2500
2517612	GED0358501S	1	25	85	90	2800
2517604	GED0359001S	1	25	90	85	4400
2517582	GED0359501S	1	25	95	85	4500
2496089	GED0354001S	1	25	100	85	4600

GED035

SOCKET 1" HEXAGON INCH
 ▽ Hand-operated



25
 1"
 "AF

Code	No.	□"	□	Ø "AF	l mm	l ₂
2515946	GED0354002S	1	25	1.7/16	65	550
2517922	GED0354003S	1	25	1.1/2	65	680
2517914	GED0354004S	1	25	1.5/8	70	730
2500361	GED0354005S	1	25	1.11/16	65	710
2500256	GED0354006S	1	25	1.13/16	65	710
2517906	GED0354007S	1	25	1.7/8	65	730
2523035	GED0354008S	1	25	2	70	930
2515938	GED0354009S	1	25	2.1/16	70	950
2515911	GED0354010S	1	25	2.3/16	75	1130
2517884	GED0354012S	1	25	2.3/8	75	1130
2517892	GED0354011S	1	25	2.1/4	75	1350
2515903	GED0354013S	1	25	2.7/16	75	1400
2515873	GED0354014S	1	25	2.9/16	75	1500
2517876	GED0354015S	1	25	2.5/8	75	1550
2517868	GED0354016S	1	25	2.3/4	85	1750
2500132	GED0354017S	1	25	2.13/16	85	1750
2500000	GED0354018S	1	25	2.15/16	85	2300
2523027	GED0354025S	1	25	3	85	2350
2517841	GED0354019S	1	25	3.1/8	85	2500
2517825	GED0354020S	1	25	3.3/8	90	2800
2517817	GED0354021S	1	25	3.1/2	90	4400
2517809	GED0354022S	1	25	3.3/4	90	4500
2517795	GED0354023S	1	25	3.7/8	90	4600
2517787	GED0354024S	1	25	4.1/4	90	5000

GED0360

REVERSIBLE RATCHET 1"
 ▽ For hand-operated sockets



25
 1"

Code	No.	□"	□	l mm	l ₂
2506416	GED0360100C	1	25	550	340

GED0360

RATCHET HANDLE WITH COUPLER 1"
 ▽ For hand-operated sockets



25
 1"

Code	No.	□"	□	l mm	l ₂
2499258	GED0361100C	1	25	550	3500

GED042

EXTENSION 1"
 ▽ For hand-operated sockets

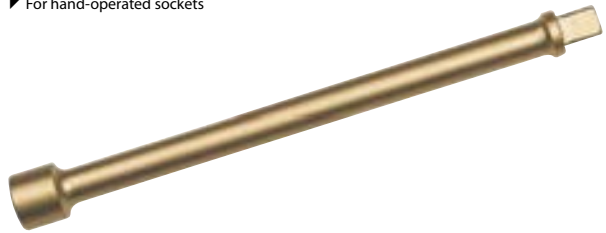

25
 1"

Code	No.	□"	□	l mm	l ₂
2510227	GED0421510S	1	25	100	800
2510219	GED0421520S	1	25	250	1400
2510200	GED0421522S	1	25	400	2090

GED0410

SWIVEL HANDLE 1"
 ▽ For hand-operated sockets

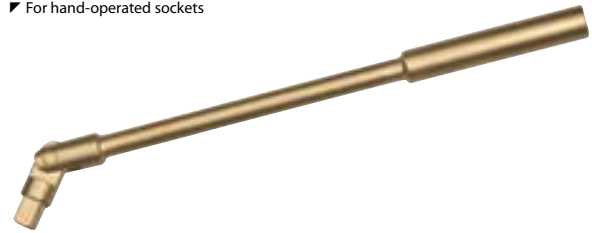

25
 1"

Code	No.	□"	□	l mm	l ₂
2511835	GED0410100S	1	25	380	1200

GED0400

SLIDING T BAR 1"
 ▽ For hand-operated sockets



25
 1"

Code	No.	□"	□	l mm	l ₂
2513668	GED0400139S	1	25	700	3985

GED0400
REDUCER 1" TO 3/4"
 For hand-operated sockets



25
1"
20
3/4"

Code	No.	□"	□	■"	■	(mm)	↕
2507943	GED04001425	1	25	3/4	25.0	75	540

GED0400
COUPLER 1"
 For hand-operated sockets



25
1"

Code	No.	■"	■	(mm)	↕
2507978	GED04001405	1	25	68.0	325

GED0400
UNIVERSAL JOINT 1"
 For hand-operated sockets



25
1"

Code	No.	■"	■	(mm)	↕
2515172	GED04001415	1	25	141	1450

GED0400
L-HANDLE 1"
 For hand-operated sockets



25
1"

Code	No.	■"	■	(mm)	↕
2511843	GED04001435	1	25	300	1000

GED0400
SPEED BRACE 1"
 For hand-operated sockets



25
1"

Code	No.	■"	■	(mm)	↕
2515083	GED04001445	1	25	380	1400

GED0400
SWIVEL HANDLE WITH SLIDING T 1"



25
1"

Code	No.	■"	■	(mm)	↕
2496070	GED04001455	1	25	660	1700

GED0440
SCREWDRIVER BIT SOCKET 1" for in-hex screws
 Hand-operated
 With welded-in hexagon pin



25
1"

Code	No.	□"	□	● mm	(mm)	↕
2495996	GED04400485	1	25	17	90	580
2495961	GED04400495	1	25	19	90	665
2495953	GED04400505	1	25	22	90	710
2495945	GED04400515	1	25	24	90	765
2495937	GED04400525	1	25	27	90	860
2495929	GED04401005	1	25	30	90	910
2495910	GED04401015	1	25	32	90	950
2495902	GED04401025	1	25	36	90	990
2495899	GED04401035	1	25	41	100	1200
2495880	GED04401125	1	25	46	100	1400

GED0430
SOCKET SET 1"
 In wooden case with non-sparking hinge



25
1"

Code	No.	Contents	pieces	↕
2522829	GED04300065	1 Reversible ratchet 1" 1 Extension 1" 250 mm 1 Extension 1" 400 mm 1 socket 1" each 36 41 46 50 55 60 65 70 75 80 mm 1.1/2 1.5/8 1.7/8 2 2.1/16 2.1/4 2.3/8 2.9/16 2.3/4 3AF	24	33100
2503190	GED04300075	1 Reversible ratchet 1" 1 Extension 1" 200 mm 1 Extension 1" 400 mm 1 socket 1" each 36 41 46 50 55 60 65 70 75 80 mm	14	21100

IMPACT SOCKETS AND ACCESSORIES

1/2" SQUARE DRIVE

GED0351

IMPACT SOCKET 1/2" HEXAGON

- Machine-operated
- With groove and through bore
- Heavy-duty model

12.5

1/2"



Code	No.	□"	□	Ø mm	↳ mm ↵	↳ mm ↵
2512939	GED0351028S	1/2	12.5	10	35	80
2512920	GED0351029S	1/2	12.5	11	35	80
2512912	GED0351030S	1/2	12.5	12	40	85
2512904	GED0351031S	1/2	12.5	13	40	85
2512890	GED0351032S	1/2	12.5	14	40	85
2512882	GED0351033S	1/2	12.5	15	40	90
2512874	GED0351034S	1/2	12.5	16	40	90
2512866	GED0351035S	1/2	12.5	17	40	120
2512858	GED0351036S	1/2	12.5	18	40	125
2512823	GED0351037S	1/2	12.5	19	40	125
2512815	GED0351038S	1/2	12.5	21	40	125
2512807	GED0351039S	1/2	12.5	22	40	120
2512793	GED0351040S	1/2	12.5	23	40	140
2512963	GED0351024S	1/2	12.5	24	48	160
2512947	GED0351027S	1/2	12.5	27	45	190
2512998	GED0351015S	1/2	12.5	30	45	210
2512971	GED0351016S	1/2	12.5	32	45	220

GED0351

IMPACT SOCKET 1/2" HEXAGON, LONG

- Machine-operated
- With groove and through bore
- Heavy-duty model

12.5

1/2"



Code	No.	□"	□	Ø mm	↳ mm ↵	↳ mm ↵
2506459	GED0351041S	1/2	12.5	8	85	120
2503611	GED0351042S	1/2	12.5	10	85	140
2503603	GED0351043S	1/2	12.5	13	85	175
2503581	GED0351044S	1/2	12.5	14	85	185
2503573	GED0351045S	1/2	12.5	16	85	245
2503565	GED0351046S	1/2	12.5	17	85	250
2503557	GED0351047S	1/2	12.5	18	85	265
2503530	GED0351048S	1/2	12.5	19	85	270
2503522	GED0351049S	1/2	12.5	21	85	305
2503514	GED0351051S	1/2	12.5	22	85	330
2503506	GED0351052S	1/2	12.5	23	85	350
2503492	GED0351053S	1/2	12.5	24	85	370
2503484	GED0351054S	1/2	12.5	27	85	435
2503646	GED0351017S	1/2	12.5	30	85	460
2503638	GED0351018S	1/2	12.5	32	85	490

GED0351

IMPACT SOCKET 1/2"

- Machine-operated
- With welded-in hexagon pin

12.5

1/2"



Code	No.	□"	□	Ø mm	↳ mm ↵	↳ mm ↵
2523779	GED0351055S	1/2	12.5	5	44	63
2523760	GED0351056S	1/2	12.5	6	44	65
2523752	GED0351057S	1/2	12.5	8	44	75
2518120	GED0351058S	1/2	12.5	10	44	90
2518112	GED0351059S	1/2	12.5	12	50	125
2518104	GED0351060S	1/2	12.5	14	50	130
2518074	GED0351061S	1/2	12.5	17	50	150
2518171	GED0351019S	1/2	12.5	22	50	170
2518163	GED0351020S	1/2	12.5	24	60	210
2518155	GED0351021S	1/2	12.5	27	60	240
2518147	GED0351022S	1/2	12.5	30	60	260
2518139	GED0351023S	1/2	12.5	32	60	270

GED035

EXTENSION FOR IMPACT SOCKETS 1/2"

12.5

1/2"



Code	No.	□"	□	↳ mm ↵	↳ mm ↵
2499312	GED0351110S	1/2	12	100	250
2499398	GED0351062S	1/2	12	200	380
2499371	GED0351063S	1/2	12	250	470

GED035

CONVERTOR FOR IMPACT SOCKETS 1/2" TO 3/4"

12.5

1/2"

20

3/4"



Code	No.	□"	□	□"	□	↳ mm ↵	↳ mm ↵
2496372	GED0351064S	1/2	12.5	3/4	20.0	45	145

GED035
REDUCER FOR IMPACT SOCKETS 1/2" TO 1/4"



12.5
1/2
6.3
1/4

Code	No.	□"	□	■"	■	↳mm↳	↳
2503476	GED0351065S	1/2	12.5	1/4	6.3	44	25

GED035
UNIVERSAL JOINT FOR IMPACT SOCKETS 1/2"



12.5
1/2

Code	No.	■"	■	↳mm↳	↳
2496364	GED0351066S	1/2	12.5	72	175

GED035
SAFETY RING FOR IMPACT SOCKETS 1/2"



Code	No.	Use	∅	↳
2523744	GED0351067S	up to size 14 mm	19	5
2523736	GED0351068S	up from size 15 mm	24	15

GED035
SAFETY PIN FOR IMPACT SOCKETS 1/2"



Code	No.	Use	∅	↳mm↳	↳
2518066	GED0351069S	up to size 14 mm	3	20	10
2523728	GED0351070S	up from size 15 mm	3	25	15

3/4" SQUARE DRIVE

GED0351
IMPACT SOCKET 3/4" HEXAGON

- Machine-operated
- With groove and through bore
- Heavy-duty model



20
3/4

Code	No.	□"	□	∅mm	↳mm↳	↳
2512785	GED0351071S	3/4	20	17	45	295
2512777	GED0351072S	3/4	20	18	45	305
2512769	GED0351073S	3/4	20	19	45	305
2512750	GED0351074S	3/4	20	22	48	350
2512742	GED0351075S	3/4	20	24	55	340
2512734	GED0351076S	3/4	20	27	55	380
2512718	GED0351077S	3/4	20	30	50	400
2512696	GED0351078S	3/4	20	32	55	480
2512688	GED0351079S	3/4	20	33	52	425
2512661	GED0351080S	3/4	20	34	55	475
2512653	GED0351081S	3/4	20	36	60	600
2512645	GED0351082S	3/4	20	38	58	485
2512637	GED0351083S	3/4	20	41	65	800
2512629	GED0351109S	3/4	20	46	65	950
2512610	GED0351204S	3/4	20	50	72	1300
2512602	GED0351205S	3/4	20	55	76	1470
2512580	GED0351206S	3/4	20	60	82	1720

GED0351
IMPACT SOCKET 3/4" HEXAGON, LONG

- Machine-operated
- With groove and through bore
- Heavy-duty model



20
3/4

Code	No.	□"	□	∅mm	↳mm↳	↳
2503468	GED0351084S	3/4	20	17	90	745
2503441	GED0351085S	3/4	20	19	90	730
2503433	GED0351086S	3/4	20	21	90	750
2503417	GED0351087S	3/4	20	22	90	750
2503409	GED0351088S	3/4	20	24	90	735
2503395	GED0351089S	3/4	20	27	90	665
2503387	GED0351090S	3/4	20	30	90	625
2503379	GED0351091S	3/4	20	32	90	795
2503360	GED0351092S	3/4	20	33	90	715
2503352	GED0351093S	3/4	20	34	90	860
2503344	GED0351094S	3/4	20	36	90	745
2503336	GED0351095S	3/4	20	41	90	925
2503328	GED0351114S	3/4	20	46	90	1150
2503689	GED0350122S	3/4	20	50	90	1610
2503662	GED0350123S	3/4	20	55	90	1800
2503654	GED0350124S	3/4	20	60	90	2150

GED0351

IMPACT SOCKET 3/4"

- Machine-operated
- With welded-in hexagon pin



20
3/4"

Code	No.	□"	□	● mm	↳ mm	↳
2518058	GED0351096S	3/4	20	14	50	295
2518031	GED0351097S	3/4	20	17	50	335
2518023	GED0351098S	3/4	20	19	50	345
2518015	GED0351099S	3/4	20	22	50	395

GED035

SAFETY RING FOR IMPACT SOCKETS 3/4"



Code	No.	∅	↳
2499320	GED0351107S	36	5

GED035

EXTENSION FOR IMPACT SOCKETS 3/4"



20
3/4"

Code	No.	□"	□	↳ mm	↳
2499363	GED0351101S	3/4	20	100	400
2499355	GED0351102S	3/4	20	250	1300
2499347	GED0351103S	3/4	20	380	1500
2499304	GED0351111S	3/4	20	430	2100

GED035

SAFETY PIN FOR IMPACT SOCKETS 3/4"



Code	No.	∅	↳ mm	↳
2523701	GED0351108S	4	35	5

GED035

CONVERTOR FOR IMPACT SOCKETS 3/4" TO 1"



20
3/4"
25
1"

Code	No.	□"	□	□"	□	↳ mm	↳
2499339	GED0351104S	3/4	20	1	25.0	65	455

1" SQUARE DRIVE

GED035

IMPACT SOCKET 1" HEXAGON

- Machine-operated
- With groove and thread bore
- Heavy-duty model



25
1"

Code	No.	□"	□	∅ mm	↳ mm	↳
2514400	GED0351115S	1	25	22	55	615
2514354	GED0352400S	1	25	24	60	515
2514346	GED0352700S	1	25	27	65	700
2514338	GED0353000S	1	25	30	60	705
2514303	GED0353200S	1	25	32	57	700
2514397	GED0351120S	1	25	33	59	715
2514389	GED0351121S	1	25	34	59	750
2514281	GED0353600S	1	25	36	70	870
2514370	GED0351123S	1	25	38	62	800
2514273	GED0354100S	1	25	41	70	805
2514362	GED0351125S	1	25	42	62	865
2514265	GED0354600S	1	25	46	80	1420
2514257	GED0355000S	1	25	50	70	1250
2514249	GED0355500S	1	25	55	90	1930
2514230	GED0356000S	1	25	60	90	2100
2514222	GED0356500S	1	25	65	90	2300
2514214	GED0357000S	1	25	70	95	2400
2514206	GED0357500S	1	25	75	95	3200
2514184	GED0358000S	1	25	80	96	3750

GED035

REDUCER FOR IMPACT SOCKETS 3/4" TO 1/2"



20
3/4"
12.5
1/2"

Code	No.	□"	□	□"	□	↳ mm	↳
2496356	GED0351105S	3/4	20	1/2	12.5	65	355

GED035

UNIVERSAL JOINT FOR IMPACT SOCKETS 3/4"



20
3/4"

Code	No.	□"	□	↳ mm	↳
2496321	GED0351106S	3/4	20	110	620

GED0351

IMPACT SOCKET 1" HEXAGON, LONG

- ▶ Machine-operated
- ▶ With groove and through bore
- ▶ Heavy-duty model



Code	No.	□"	□	○mm	↳mm↳	↳↳
2508354	GED03511345	1	25	22	100	1140
2508346	GED03511355	1	25	24	100	1250
2508311	GED03511365	1	25	27	100	1230
2508303	GED03511375	1	25	30	100	1185
2508281	GED03511385	1	25	32	100	1150
2508273	GED03511395	1	25	33	100	1185
2508265	GED03511405	1	25	34	100	1140
2508257	GED03511415	1	25	36	100	1160
2508249	GED03511425	1	25	38	100	1260
2508230	GED03511435	1	25	41	100	1300
2508222	GED03511445	1	25	46	100	1495

GED035

CONVERTOR FOR IMPACT SOCKETS 1" TO 1.1/2"

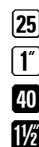

Code	No.	□"	□	■"	■	↳mm↳	↳↳
2523612	GED03511545	1	25	1.1/2	40.0	115	1105

GED035

REDUCER FOR IMPACT SOCKETS 1" TO 3/4"

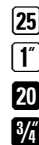

Code	No.	□"	□	■"	■	↳mm↳	↳↳
2508192	GED03511555	1	25	3/4	20	75	660

GED0351

IMPACT SOCKET 1"

- ▶ Machine-operated
- ▶ With welded-in hexagon pin



Code	No.	□"	□	●mm	↳mm↳	↳↳
2496305	GED03511455	1	25	22	80	605
2496291	GED03511465	1	25	24	80	650
2496283	GED03511475	1	25	27	80	655
2496275	GED03511485	1	25	30	80	675
2496267	GED03511495	1	25	32	80	660
2496399	GED03510255	1	25	36	100	1050
2496380	GED03510265	1	25	41	100	1100
2496313	GED03511285	1	25	46	100	1250

GED035

UNIVERSAL JOINT FOR IMPACT SOCKETS 1"



Code	No.	■"	■	↳mm↳	↳↳
2499290	GED03511565	1	25	141	1430

GED035

SAFETY RING FOR IMPACT SOCKETS 1"



Code	No.	Use	∅	↳↳
2499274	GED03511575	up to size 70 mm	45	10
2518007	GED03511585	for size 75+80 mm	75	25

GED035

EXTENSION FOR IMPACT SOCKETS 1"



Code	No.	■"	■	↳mm↳	↳↳
2506440	GED03511515	1	25	100	850
2506432	GED03511525	1	25	250	1550
2506424	GED03511535	1	25	400	2050

GED035

SAFETY PIN FOR IMPACT SOCKETS 1"



Code	No.	Use	∅	↳mm↳	↳↳
2523604	GED03511595	up to size 70 mm	5	45	5
2515989	GED03511605	for size 75+80 mm	6	75	15

1.1/2" SQUARE DRIVE

GED035

IMPACT SOCKET 1.1/2" HEXAGON

- Machine-operated
- With groove and through bore
- Heavy-duty model



Code	No.	□*	□	Ø mm	↳ mm	↳
2510367	GED0350121S	1.1/2	40	41	80	2180
2510359	GED0351116S	1.1/2	40	46	80	2245
2510340	GED0351117S	1.1/2	40	50	82	2350
2510332	GED0351118S	1.1/2	40	55	88	2475
2510324	GED0351119S	1.1/2	40	60	91	2755
2510316	GED0351122S	1.1/2	40	65	95	3225
2510308	GED0351124S	1.1/2	40	70	100	3595
2510294	GED0351126S	1.1/2	40	75	105	3720
2510278	GED0351127S	1.1/2	40	80	110	4345
2510251	GED0358500S	1.1/2	40	85	120	5075
2510243	GED0359000S	1.1/2	40	90	120	5630
2510235	GED0359500S	1.1/2	40	95	125	7765
2508389	GED0351000S	1.1/2	40	100	125	8380
2508370	GED0351050S	1.1/2	40	105	125	9550
2508362	GED0351100S	1.1/2	40	110	135	10615
2508214	GED0351150S	1.1/2	40	115	135	10800
2508060	GED0351200S	1.1/2	40	120	145	11785
2508052	GED0351250S	1.1/2	40	125	145	11900

GED035

IMPACT SOCKET 1.1/2" HEXAGON, LONG

- Machine-operated
- With groove and through bore
- Heavy-duty model



Code	No.	□*	□	Ø mm	↳ mm	↳
2496259	GED0351161S	1.1/2	40	41	140	4420
2496240	GED0351162S	1.1/2	40	46	140	4420
2496232	GED0351163S	1.1/2	40	50	140	4255
2496216	GED0351164S	1.1/2	40	55	140	4330
2496208	GED0351165S	1.1/2	40	60	140	4710
2496194	GED0351166S	1.1/2	40	65	140	5005
2496186	GED0351167S	1.1/2	40	70	140	5250
2496178	GED0351168S	1.1/2	40	75	140	5465
2496151	GED0351169S	1.1/2	40	80	140	5615
2496143	GED0351170S	1.1/2	40	85	140	6175
2496135	GED0351171S	1.1/2	40	90	140	6825
2496127	GED0351172S	1.1/2	40	95	150	10260
2523590	GED0351173S	1.1/2	40	100	150	10395
2523582	GED0351174S	1.1/2	40	105	150	11430
2523566	GED0351175S	1.1/2	40	110	160	12855
2523558	GED0351176S	1.1/2	40	115	160	12680
2523531	GED0351177S	1.1/2	40	120	170	14380

GED035

REDUCER FOR IMPACT SOCKETS 1.1/2" TO 1"

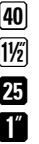

Code	No.	□*	□	■*	■	↳ mm	↳
2496119	GED0351178S	1.1/2	40	1	25	95	2300

GED035

SAFETY RING FOR IMPACT SOCKETS 1.1/2"



Code	No.	Use	Ø	↳
2515970	GED0351179S	up to size 90 mm	75	25
2517981	GED0351180S	up from size 95 mm	114	40

GED035

SAFETY PIN FOR IMPACT SOCKETS 1.1/2"



Code	No.	Use	Ø	↳ mm	↳
2500493	GED0351181S	up to size 90 mm	8	110	40
2515962	GED0351182S	up from size 95 mm	8	110	40



2.1/2" SQUARE DRIVE

GED035

IMPACT SOCKET 2.1/2" HEXAGON

- Machine-operated
- With groove and through bore
- Heavy-duty model



Code	No.	□"	□	○ mm	↳ mm ↲	↳ ↲
2508184	GED0351183S	2.1/2	63	75	120	9600
2508176	GED0351184S	2.1/2	63	80	120	10100
2508168	GED0351185S	2.1/2	63	85	130	10000
2508141	GED0351186S	2.1/2	63	90	130	10100
2508133	GED0351187S	2.1/2	63	95	130	11200
2508125	GED0351188S	2.1/2	63	100	140	12050
2508117	GED0351189S	2.1/2	63	105	140	12600
2508109	GED0351190S	2.1/2	63	110	150	13800
2508095	GED0351191S	2.1/2	63	115	150	14100
2508079	GED0351192S	2.1/2	63	120	155	15000

GED035

REDUCER FOR IMPACT SOCKETS 2.1/2" TO 1.1/2"

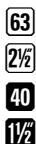

Code	No.	□"	□	■"	■	↳ mm ↲	↳ ↲
2496097	GED0351193S	2.1/2	63	1.1/2	40	145	6200

GED035

SAFETY RING FOR IMPACT SOCKETS 2.1/2"



Code	No.	Use	∅	↳ ↲
2517973	GED0351194S	up from size 95 mm	114	40

GED035

SAFETY PIN FOR IMPACT SOCKETS 2.1/2"



Code	No.	Use	∅	↳ mm ↲	↳ ↲
2515954	GED0351195S	up from size 95 mm	8	110	40

SCREWDRIVER BITS NON-SPARKING

GED

SCREWDRIVER BIT 1/4" for slotted head screws



Code	No.	mm	●"	●	↳ ↲
2522136	GED1264045C	4.5	1/4	6.3	5
2522101	GED1264065C	6.5	1/4	6.3	8
2495708	GED1264080C	8.0	1/4	6.3	10

GED

SCREWDRIVER BIT 1/4" for cross-slotted head screws PH



Code	No.	∅ PH	●"	●	↳ ↲
2502895	GED1264001C	1	1/4	6.3	5
2502887	GED1264002C	2	1/4	6.3	8
2502879	GED1264003C	3	1/4	6.3	10
2502860	GED1264004C	4	1/4	6.3	13

GED

SCREWDRIVER BIT 1/4" for in-hex screws



Code	No.	● mm	●"	●	↳ ↲
2495767	GED1264030C	3	1/4	6.3	4
2495759	GED1264040C	4	1/4	6.3	5
2495732	GED1264050C	5	1/4	6.3	5
2495724	GED1264060C	6	1/4	6.3	7
2495716	GED1264070C	7	1/4	6.3	7
2522098	GED1264100C	10	1/4	6.3	9

GED

SCREWDRIVER BIT 1/4" for recessed TORX® head screws with pilot

- TORX® = reg. trademark of Acument Intellectual Properties, LLC. USA



Code	No.	∅	●"	●	↳ ↲
2509733	GED1264101C	T10	1/4	6.3	5
2509725	GED1264102C	T15	1/4	6.3	10
2509717	GED1264103C	T20	1/4	6.3	20
2509709	GED1264104C	T25	1/4	6.3	30
2509695	GED1264105C	T27	1/4	6.3	35
2509687	GED1264106C	T30	1/4	6.3	40
2509679	GED1264107C	T40	1/4	6.3	55

SCREWDR



WEDC

SCREWDRIVERS NON-SPARKING



*funkenfrei

SCREWDRIVERS NON-SPARKING

GED080

SCREWDRIVER for slotted head screws



Code	No.	mm	mm	mm
2522616	GED0803075C	3.0	75	30
2497441	GED0804510C	4.5	100	55
2497336	GED0804515C	4.5	150	60
2517213	GED0806010C	6.0	100	80
2517205	GED0806015C	6.0	150	85
2517140	GED0808015C	8.0	150	145
2515733	GED0801020C	10.0	200	185
2515725	GED0801030C	10.0	300	230

GED080

SCREWDRIVER for slotted head screws, parallel blade

With parallel blade



Code	No.	mm	mm	mm
2517248	GED0800380C	3.0	75	25
2515784	GED0800480C	4.0	150	55
2515768	GED0800580C	5.0	150	75
2515741	GED0800680C	6.0	200	110
2522624	GED0800780C	6.5	300	150

GED081

SCREWDRIVER for cross-slotted head screws PH



Code	No.	PH	mm	mm
2512564	GED0810000C	0	60	35
2512556	GED0810010C	1	80	60
2512548	GED0810020C	2	100	90
2512521	GED0810030C	3	150	165
2512513	GED0810040C	4	200	270

GED080

SCREWDRIVER SETS

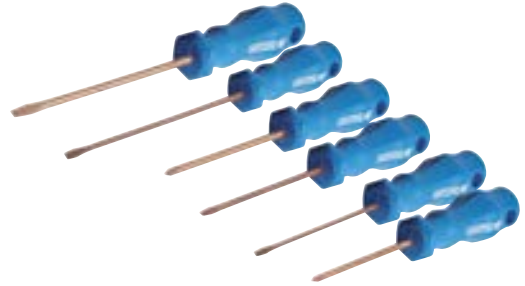
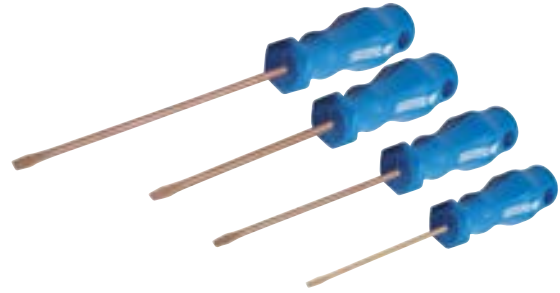

Code	No.	Contents	pieces	mm
2499088	GED0800001C	⊖ 3x75 mm ⊖ 4,5x100 mm ⊖ 6x150 mm ⊖ 8x150 mm	4	315
2499061	GED0800002C	⊖ 4,5x100 mm ⊖ 6x100 mm 6x150 mm ⊖ 8x150 mm ⊕ PH1 PH2	6	515
2495872	GED0800003C	⊖ 4,5x100 mm 4,5x150 mm ⊖ 6x100 mm 6x150 mm ⊖ 8x150 mm ⊖ 10x200 mm ⊕ PH1 PH2 PH3 PH4	10	1200
2499053	GED0800004C	⊕ PH1 PH2 PH3 PH4	4	585

GED080

SCREWDRIVER for recessed TORX® screws

TORX® = reg. trademark of Acument Intellectual Properties, LLC. USA





Code	No.	T	mm	mm
2507757	GED0807005C	T5	70	30
2507749	GED0807006C	T6	70	32
2507730	GED0807007C	T7	70	32
2507722	GED0807008C	T8	70	32
2507706	GED0807009C	T9	70	32
2506165	GED0807010C	T10	80	41
2506157	GED0807015C	T15	80	45
2506149	GED0807020C	T20	90	48
2506130	GED0807025C	T25	90	52
2506122	GED0807027C	T27	110	78
2506106	GED0807030C	T30	110	84
2506092	GED0807040C	T40	120	115
2506084	GED0807045C	T45	120	136
2506076	GED0807050C	T50	120	150

GED025

HEXAGON ALLEN KEY WITH HANDLE straight, for in-hex screws



 mm

Code	No.	mm		
2497409	GED0251043S	3	100	35
2497395	GED0251044S	4	100	50
2497387	GED0251045S	5	100	60
2497379	GED0251046S	6	125	90
2497360	GED0251047S	8	150	140
2497352	GED0251048S	10	150	210
2496682	GED0252056S	12	150	280

GED025

HEXAGON ALLEN KEY WITH HANDLE angled, for in-hex screws



 mm



Code	No.	mm	L ₁	L ₂	
2492415	GED0251038S	3	75	20	25
2492407	GED0251039S	4	75	25	40
2492393	GED0251040S	5	80	28	50
2492385	GED0251041S	6	80	32	75
2492377	GED0251042S	8	120	36	140
2492334	GED0251499S	10	120	40	220
2492520	GED0250500S	12	120	45	290

GED080

HEXAGON ALLEN KEY WITH HANDLE straight, for in-hex screws, with ball end



 mm

Code	No.	mm		
2515717	GED0807055C	3	100	35
2515709	GED0807060C	4	100	50
2515695	GED0807065C	5	100	60
2515687	GED0807070C	6	125	90
2515679	GED0807075C	8	150	140
2497204	GED0807080C	10	150	210
2497085	GED0807085C	12	150	280

GED025

HEXAGON ALLEN KEY SET for in-hex screws

▀ In blue plastic holder

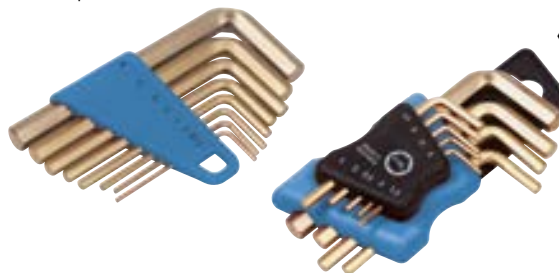

 mm

Code	No.	Contents	pieces	
2492660	GED0250001S	● 2 2,5 3 4 5 6 8 10 mm	8	245
2519313	GED0250003S	● 1,5 2 2,5 3 4 5 6 8 10 mm	9	205

GED025

HEXAGON ALLEN KEY SET for in-hex screws INCH

▀ In blue plastic holder

▀ Illustration similar

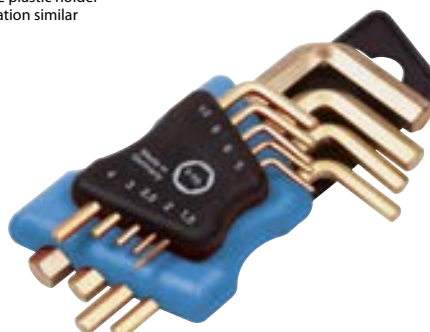

 "AF

Code	No.	Contents	pieces	
2519348	GED0250002S	● 1/16 5/64 3/32 1/8 5/32 3/16 7/32 1/4 5/16 3/8"	10	178

GED025

HEXAGON ALLEN KEY SET for in-hex screws, extra long

▀ In blue plastic holder

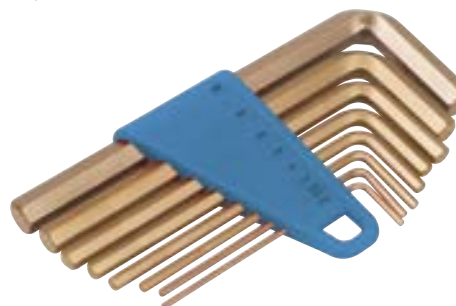

 mm

Code	No.	Contents	pieces	
2492652	GED0250005S	● 2 2,5 3 4 5 6 8 10 mm	8	400
2519275	GED0250004S	● 1,5 2 2,5 3 4 5 6 8 10 mm	9	464

GED025

HEXAGON ALLEN KEY SET for in-hex screws, with ball end

▀ In blue plastic holder

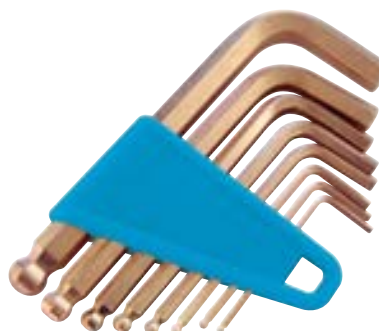

 mm

Code	No.	Contents	pieces	
2519224	GED0250066C	● 2 2,5 3 4 5 6 8 10 mm	8	250
2504057	GED0250067C	● 1,5 2 2,5 3 4 5 6 8 10 mm	9	260

GED025

HEXAGON ALLEN KEY for in-hex screws

Similar to DIN ISO 2936



Code	No.	mm	mm	
2504073	GED0250015C	1.5	55	3
2508532	GED0250020C	2.0	55	2
2504065	GED0250025C	2.5	55	4
2508524	GED0250030S	3.0	60	7
2508516	GED0250040S	4.0	70	12
2508508	GED0250050S	5.0	80	20
2508494	GED0250060S	6.0	90	33
2508486	GED0250070S	7.0	95	45
2508478	GED0250080S	8.0	100	65
2508451	GED0250090S	9.0	105	85
2506904	GED0250100S	10.0	120	100
2506890	GED0250110S	11.0	119	130
2506882	GED0250120S	12.0	125	165
2506874	GED0250130S	13.0	132	200
2506866	GED0250140S	14.0	140	250
2506831	GED0250170S	17.0	160	405
2506823	GED0250180S	18.0	170	500
2506815	GED0250190S	19.0	180	570
2506807	GED0250220S	22.0	200	950
2506793	GED0250240S	24.0	224	1250
2506785	GED0250270S	27.0	250	1800
2506777	GED0250300S	30.0	280	2500
2506769	GED0250320S	32.0	315	3100
2506750	GED0250360S	36.0	355	4500
2506742	GED0250410S	41.0	400	5300

GED025

HEXAGON ALLEN KEY for in-hex screws INCH



Code	No.	"AF"	mm	
2504030	GED0251001C	3/64	55	1
2504022	GED0251002C	1/16	55	2
2504014	GED0251003C	5/64	55	2
2504006	GED0251004C	3/32	55	4
2506726	GED0251005C	1/8	60	7
2503999	GED0251006C	5/32	70	12
2503980	GED0251007S	3/16	80	20
2503972	GED0251008S	7/32	80	20
2506718	GED0251009S	1/4	90	33
2503964	GED0251010S	5/16	100	65
2506696	GED0251011S	3/8	120	100
2503956	GED0251012S	7/16	119	130
2506688	GED0251013S	1/2	125	165
2503948	GED0251014S	9/16	140	250

Code	No.	"AF"	mm	
2506661	GED0251015S	5/8	140	266
2499789	GED0251016S	11/16	160	405
2506653	GED0251017S	3/4	180	570
2506645	GED0251018S	7/8	200	950
2510812	GED0251019S	1	224	1260
2497433	GED0251020S	1.1/16	216	3080
2499762	GED0251021S	1.1/8	230	3300
2499754	GED0251022S	1.1/4	230	3300
2497425	GED0251023S	1.5/16	235	3520
2499746	GED0251024S	1.3/8	235	3520
2497417	GED0251025S	1.7/16	241	3740
2499738	GED0251026S	1.1/2	241	3740
2499711	GED0251027S	1.5/8	241	3740

GED025

HEXAGON ALLEN KEY for in-hex screws, extra long



Code	No.	mm	mm	
2492512	GED0251030S	3	126	6
2492504	GED0251031S	4	142	12
2492490	GED0251032S	5	160	18
2492482	GED0251033S	6	180	30
2492474	GED0251034S	8	200	70
2492466	GED0251035S	10	224	120
2492458	GED0251036S	12	250	190
2492423	GED0251037S	14	280	300
2492350	GED0251123S	17	320	380
2492342	GED0251124S	19	360	490

GED025

HEXAGON ALLEN KEY for in-hex screws, with ball end



Code	No.	mm	mm	
2507846	GED0251500C	1.5	45	4
2519216	GED0252000C	2.0	50	3
2507714	GED0252500C	2.5	55	5
2519321	GED0250003C	3.0	63	7
2519283	GED0250004C	4.0	70	12
2519267	GED0250005C	5.0	80	20
2519259	GED0250006C	6.0	90	32
2519240	GED0250007C	7.0	95	42
2519232	GED0250008C	8.0	100	60
2516241	GED0250010C	10.0	115	106
2516233	GED0250012C	12.0	130	205
2516225	GED0250014C	14.0	140	255

GED025
HEXAGON ALLEN KEY for in-hex screws, with ball end, extra long



Code	No.	mm	mm	
2492547	GED0250115C	3	126	8
2492644	GED0250016C	4	140	18
2492636	GED0250017C	5	160	31
2492628	GED0250018C	6	180	51
2492601	GED0250019C	7	190	75
2492539	GED0250120C	8	200	101
2492598	GED0250021C	10	224	176
2492571	GED0250022C	12	250	292
2492563	GED0250023C	14	290	370

GED080
HEXAGON ALLEN KEY WITH T-HANDLE for in-hex screws, with ball end



Code	No.	mm	mm	
2517191	GED0807090C	3	100	31
2517183	GED0807091C	4	100	38
2517175	GED0807092C	5	150	69
2517167	GED0807093C	6	150	83
2517159	GED0807094C	8	150	118
2515628	GED0807095C	10	200	225
2515636	GED0807096C	12	200	295
2515660	GED0807097C	14	200	380

GED025
HEXAGON ALLEN KEY WITH T-HANDLE for in-hex screws



Code	No.	mm	mm	
2516160	GED0251049S	3	100	31
2516152	GED0251050S	4	100	38
2516136	GED0251051S	5	100	61
2516128	GED0251052S	6	100	71
2516101	GED0251053S	8	100	97
2507951	GED0251054S	10	100	157
2508567	GED0250055S	12	100	198
2508443	GED0250056S	14	100	246

GED083
HEXAGON ALLEN KEY



Code	No.	mm	mm	
2517132	GED0831250S	4	125	25
2517124	GED0831300S	6	130	35
2515601	GED0831400S	10	140	90
2515520	GED0831900S	13	190	240

GED025
HEXAGON ALLEN KEY WITH T-HANDLE, LONG for in-hex screws



Code	No.	mm	mm	
2516217	GED0250057S	3	150	34
2516209	GED0250058S	4	150	43
2516195	GED0250059S	5	150	69
2516187	GED0250061S	6	150	83
2516179	GED0250062S	8	150	118
2508338	GED0250063S	10	150	191
2508206	GED0250064S	12	150	247
2508087	GED0250065S	14	150	312

GED014
HEXAGON ALLEN KEY for square screws



Code	No.	mm	mm	
2492903	GED0140010S	10	200	200
2492881	GED0140011S	11	200	200
2492873	GED0140012S	12	200	200
2492865	GED0140013S	13	200	200
2492857	GED0140014S	14	220	400
2492849	GED0140015S	15	220	400
2492830	GED0140016S	16	220	400
2492822	GED0140017S	17	250	600
2492792	GED0140018S	18	250	600
2492784	GED0140019S	19	250	600
2492776	GED0140020S	20	300	1000
2492768	GED0140021S	21	300	1000
2492741	GED0140022S	22	300	1000
2492733	GED0140024S	24	360	1600
2492725	GED0140025S	25	360	1600
2492717	GED0140027S	27	360	1600
2492709	GED0140028S	28	440	3200
2492695	GED0140030S	30	440	3200
2492679	GED0140032S	32	440	3200

PLIERS

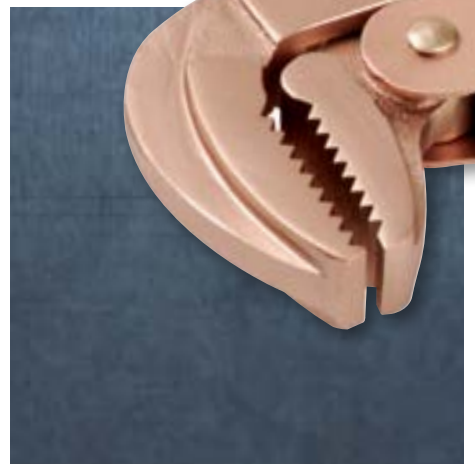
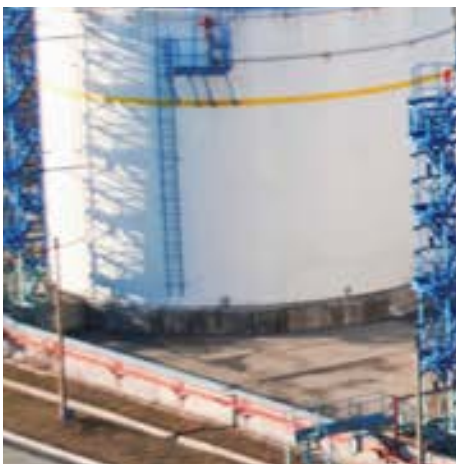

Pliers

PLIERS NON-SPARKING

NON
SPARKING



*funkenfrees

PLIERS NON-SPARKING

GED053

PIPE WRENCH, AMERICAN PATTERN



Code	No.	"inch" [E]	↳ mm [E]	↳ mm [E]
2517337	GED0530230S	3/4	230	600
2517329	GED0530300S	1	300	1125
2517310	GED0530385S	1.1/2	385	1370
2517302	GED0530460S	2	460	2450
2517299	GED0530625S	2.1/2	625	4050
2517280	GED0530850S	3.1/2	850	7350
2515849	GED0531205S	5	1205	13800

GED055

ADJUSTABLE SPANNER



Code	No.	mm [E]	↳ mm [E]	↳ mm [E]
2507838	GED0554000S	38	240	420
2507811	GED0555000S	45	240	470
2507803	GED0556000S	48	290	780
2507781	GED0557000S	58	350	1000
2507773	GED0558000S	65	350	1200
2507765	GED0559000S	70	425	1600
2507854	GED0551000S	80	500	2200
2506181	GED0551050S	105	575	3700

GED051

ELBOW PIPE WRENCH

- For working in confined spaces
- Roller secured against loss

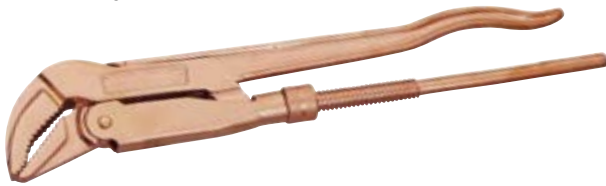

Code	No.	"inch" [E]	↳ mm [E]	↳ mm [E]
2515156	GED0510010C	1	320	820
2513641	GED0510015C	1.1/2	430	1570
2515148	GED0510020C	2	540	3200
2515121	GED0510030C	3	700	4100
2515113	GED0510040C	4	790	6200

GED051

PIPE WRENCH, SWEDISH PATTERN

- Head angled 90°
- Roller secured against loss

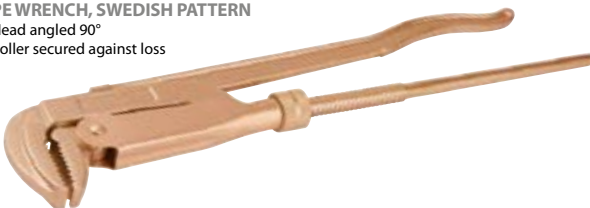

Code	No.	"inch" [E]	↳ mm [E]	↳ mm [E]
2499118	GED0510115C	1.1/2	430	1570
2506203	GED0510120C	2	540	3200

GED048

ADJUSTABLE WRENCH



Code	No.	mm [E]	↳ mm [E]	↳ mm [E]
2503174	GED0481500C	18	150	100
2503166	GED0482000C	26	200	200
2503158	GED0482500C	30	250	400
2503131	GED0483000C	36	300	700
2503123	GED0483800C	46	380	1400
2503115	GED0484500C	53	450	2700
2503107	GED0486000C	67	600	5100

GED722

CHAIN PIPE WRENCH light version

- Ideal for use in areas with restricted access
- Ratchet-type operation



Code	No.	for max. Ø	↳ mm [E]	↳ mm [E]
2521687	GED7220001S	50	600	1700
2521679	GED7220002S	100	600	2500
2498677	GED7220003S	150	600	3000
2521660	GED7220004S	450	1600	8000

GED052

CHAIN PIPE WRENCH American pattern

- High efficiency due to maximum-possible lever action



Code	No.	for max. Ø	↳ mm [E]	↳ mm [E]
2522748	GED0520510S	38	510	2650
2522721	GED0520685S	65	685	4500
2522705	GED0520915S	100	915	11500
2522691	GED0521830S	300	1830	30300

GED065

GAS PIPE PLIERS



Code	No.	Ø	↳ mm [E]	↳ mm [E]
2510197	GED0652100C	40	210	370

GED060
COMBINATION PLIERS
 ▀ Size 160 mm = handles blue dip-insulated
 ▀ Size 200 mm = with 2-component handle sleeves



Code	No.	mm	mm
2514761	GED0601600C	160	350
2514753	GED0602000C	200	425

GED066
POWER SIDE CUTTER
 ▀ With 2-component handle sleeves

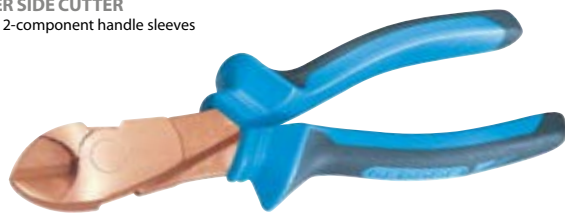

Code	No.	mm	mm
2522659	GED0662650C	190	290

GED066
POWER SIDE CUTTER, INSULATED
 ▀ Insulated up to 1000 V



Code	No.	mm	mm
2515830	GED0662651C	190	290

GED160
COMBINATION PLIERS, INSULATED
 ▀ Insulated up to 1000 V



Code	No.	mm	mm
2522047	GED1601000C	200	390

GED050
WATER PUMP PLIERS
 ▀ Handles blue dip-insulated



Code	No.	mm	mm	mm
2506262	GED0502500C	30	250	370
2506238	GED0503000C	50	300	560
2506211	GED0504000C	110	400	1680

GED160
COMBINATION PLIERS, ADJUSTABLE
 ▀ Handles blue dip-insulated

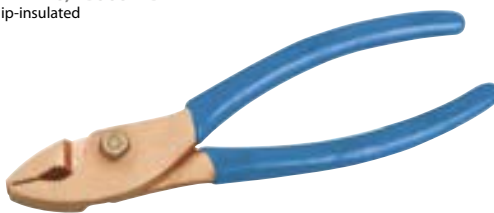

Code	No.	mm	mm
2513838	GED1602000C	200	340

GED060
WATER PUMP PLIERS
 ▀ Box joint



Code	No.	mm	mm	mm
2506173	GED0602500C	30	250	350

GED066
SIDE CUTTER
 ▀ With 2-component handle sleeves



Code	No.	mm	mm
2510189	GED0661650C	165	200

GED062
ROUND NOSE PLIERS
 ▀ With 2-component handle sleeves



Code	No.	mm	mm
2515059	GED0621200C	120	90
2515032	GED0621600C	160	160

GED061

PINCER

- Handles blue dip-insulated

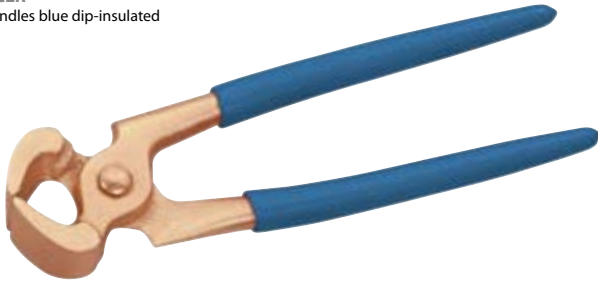

Code	No.	mm	mm
2515075	GED0612000C	200	430
2515067	GED0612300C	230	520

GED061

END CUTTING NIPPERS heavy-duty version

- Handles blue dip-insulated



Code	No.	mm	mm
2522683	GED0611750C	175	260

GED064

FLAT NOSE PLIERS

- Size 120 mm = with 2-component handle sleeves
- Size 160 mm = handles blue dip-insulated



Code	No.	mm	mm
2514737	GED0641200C	120	50
2514729	GED0641600C	160	150

GED063

TELEPHONE PLIERS straight pattern

- With 2-component handle sleeves



Code	No.	mm	mm
2513633	GED0631800C	180	300

GED063

TELEPHONE PLIERS, INSULATED straight pattern

- Insulated up to 1000 V



Code	No.	mm	mm
2522667	GED0631802C	180	255

GED063

TELEPHONE PLIERS angled

- Tips angled 45°
- Handles blue dip-insulated



Code	No.	mm	mm
2522675	GED0631801C	180	245

GED061

STRIPPING PLIERS

- Self-opening, with spring and adjusting screw



Code	No.	mm	mm
2511827	GED0611550C	170	260

GED068

CIRCLIP PLIERS FOR EXTERNAL RETAINING RINGS Form A

- Handles blue dip-insulated



Code	No.	mm	mm	mm
2517272	GED0680310C	3-10	140	110
2515822	GED0681025C	10-25	140	120
2515814	GED0681960C	19-60	180	220
2497824	GED0684010C	40-100	225	300
2497700	GED0688516C	85-165	310	700
2519550	GED0681253C	125-300	500	1200

GED069
CIRCLIP PLIERS FOR INTERNAL RETAINING RINGS Form C
 ▽ Handles blue dip-insulated

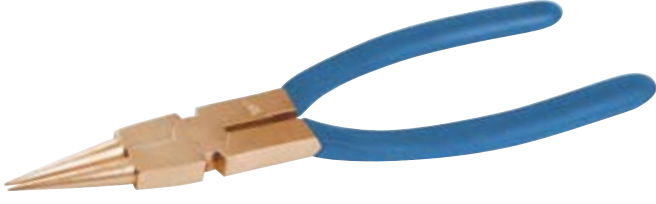

Code	No.	Ø mm	l mm	l mm
2522640	GED0690825C	8-25	140	120
2517264	GED0691960C	19-60	180	220
2515806	GED0694010C	40-100	225	300
2515792	GED0698516C	85-165	290	700
2497565	GED0691253C	125-300	500	1200

GED0702
TIN SNIPS American pattern



Code	No.	l mm	l mm
2514141	GED0702800C	300	450

GED0702
IDEAL PATTERN SNIPS reinforced
 ▽ For straight continuous and figure cuts



Code	No.	l mm	l mm
2522632	GED0702750C	280	520

GED999
BOLT CUTTERS
 ▽ Handles blue dip-insulated



Code	No.	l mm	l mm
2509385	GED9991031C	620	3400

GED0712
MULTIPURPOSE SCISSORS



Code	No.	l mm	l mm
2510170	GED0712100C	210	300

GED062
CRIMPING PLIERS
 ▽ Handles blue dip-insulated

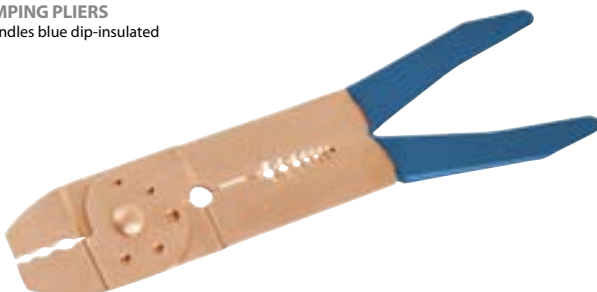

Code	No.	l mm	l mm
2514745	GED0621001C	200	120



GED725
PLIERS SET 4 pieces



Code	No.	Contents	l mm
2513099	GED7250008C	Combination pliers 200 mm Side cutter 165 mm Telephone pliers 180 mm Water pump pliers 250 mm	1500

GED0712
SCISSORS



Code	No.	l mm	l mm
2512572	GED0712000C	220	225

HAMMERS



* funkenfrei

HAMMERS NON-SPARKING



HAMMERS NON-SPARKING

GED100

ENGINEERS' HAMMER

- ▣ With hickory handle
- ▣ Similar to DIN 1041, face and pein ground



Code	No.	↕
2522594	GED1000100S	100
2522586	GED1000150S	150
2522578	GED1000200S	200
2522543	GED1000300S	300
2522527	GED1000400S	400
2522500	GED1000500S	500
2522497	GED1000600S	600
2522470	GED1000700S	700
2522454	GED1000800S	800
2522446	GED1000900S	900
2517086	GED1001000S	1000
2517078	GED1001250S	1250
2517043	GED1001500S	1500
2517027	GED1002000S	2000

GED100

ENGINEERS' HAMMER

- ▣ With nearly unbreakable fibreglass handle
- ▣ Similar to DIN 1041, face and pein ground



Code	No.	↕
2522551	GED1000300F	300
2522535	GED1000400F	400
2522519	GED1000500F	500
2522462	GED1000800F	800
2517094	GED1001000F	1000
2517051	GED1001500F	1500
2517035	GED1002000F	2000

GED104

SLEDGE HAMMER

- ▣ With hickory handle
- ▣ Similar to DIN 1042, face and pein ground



Code	No.	↕
2509873	GED1042500S	2500
2509857	GED1043000S	3000
2509830	GED1044000S	4000
2509814	GED1045000S	5000
2509806	GED1046000S	6000
2509776	GED1048000S	8000
2509768	GED1049000S	9000
2507668	GED1041000S	10000
2507641	GED1041200S	12000
2507633	GED1041500S	15000

GED104

SLEDGE HAMMER

- ▣ With nearly unbreakable fibreglass handle
- ▣ Similar to DIN 1042, face and pein ground



Code	No.	↕
2509865	GED1043000F	3000
2509849	GED1044000F	4000
2509822	GED1045000F	5000
2509792	GED1048000F	8000
2507676	GED1041000F	10000

GED103

CLUB HAMMER

- ▣ With hickory handle
- ▣ Face ground



Code	No.	↕
2510138	GED1031000S	1000
2510103	GED1031250S	1250
2510073	GED1031500S	1500
2510057	GED1032000S	2000
2510022	GED1032500S	2500
2510006	GED1033000S	3000
2509989	GED1034000S	4000
2509962	GED1035000S	5000
2509946	GED1036000S	6000
2509881	GED1038000S	8000
2507684	GED1031100S	10000

GED103

CLUB HAMMER

- ▶ With nearly unbreakable fibreglass handle
- ▶ Face ground



Code	No.	↕
2510146	GED1031000F	1000
2510111	GED1031250F	1250
2510081	GED1031500F	1500
2510065	GED1032000F	2000
2510049	GED1032500F	2500
2510014	GED1033000F	3000
2509997	GED1034000F	4000
2509970	GED1035000F	5000
2509954	GED1036000F	6000
2509938	GED1038000F	8000
2507692	GED1031100F	10000

GED113

MINING HAMMER

- ▶ With hickory handle
- ▶ Face ground



Code	No.	↕
2514095	GED1131000S	1000
2514087	GED1131500S	1500
2514060	GED1132500S	2500
2514052	GED1133500S	3500
2514044	GED1135000S	5000
2514036	GED1138000S	8000

GED113

MINING HAMMER

- ▶ With nearly unbreakable fibreglass handle
- ▶ Face ground



Code	No.	↕
2513625	GED1131000F	1000
2513617	GED1131500F	1500
2513609	GED1132500F	2500
2513595	GED1133500F	3500
2513560	GED1135000F	5000
2513552	GED1138000F	8000

GED102

ENGINEERS' HAMMER American pattern

- ▶ With hickory handle



Code	No.	↕
2522438	GED1020100S	100
2522411	GED1020150S	150
2522403	GED1020200S	200
2522381	GED1020300S	300
2522373	GED1020400S	400
2522365	GED1020500S	500
2522349	GED1020600S	600
2522330	GED1020700S	700
2522322	GED1020800S	800
2522314	GED1020900S	900
2517019	GED1021000S	1000
2517000	GED1021300S	1300
2516985	GED1021500S	1500
2516977	GED1022000S	2000

GED109

HAND HAMMER American pattern



Code	No.	↕
2522306	GED1090700S	700
2516969	GED1091200S	1200
2516950	GED1091600S	1600

GED108

SET HAMMER

- ▶ With hickory handle



Code	No.	↕
2514702	GED1081500S	1500

GED116

HOLE/DRIFT PUNCH
 With hickory handle



Code	No.	↕
2498944	GED11610005	1000
2498936	GED11620005	2000
2498898	GED11630005	3000
2498871	GED11650005	5000

GED112

MACHINIST'S HAMMER American pattern
 With hickory handle



Code	No.	↕
2505924	GED11201005	100
2505916	GED11203005	300
2505908	GED11205005	500
2505894	GED11206005	600
2505878	GED11208005	800
2505851	GED11209005	900
2503085	GED11211005	1100

GED106

CLAW HAMMER
 With hickory handle



Code	No.	↕
2514133	GED10603005	300
2514125	GED10604005	400
2514117	GED10605005	500
2514109	GED10606005	600

GED701

BRICKLAYER'S HAMMER
 With hickory handle
 Similar to DIN 5108



Code	No.	↕
2513803	GED70106005	600
2513781	GED70108005	800
2513250	GED70109005	1000

GED703

BRICKLAYER'S HAMMER American pattern
 With hickory handle



Code	No.	↕
2511754	GED70307005	700

GED105

SCALING HAMMER
 With hickory handle



Code	No.	↕
2507625	GED10502005	200
2507617	GED10504005	400
2507609	GED10505005	500
2507587	GED10506005	600
2507579	GED10508005	800
2507560	GED10509005	900
2505932	GED10514005	1400

GED702

MALLET
 With hickory handle



Code	No.	↕
2495538	GED70209005	900
2521970	GED70218005	1800
2521962	GED70227005	2700

GED704
CHISEL HAMMER
 With hickory handle



Code	No.	mm	mm	mm	mm	
2513242	GED7041300S					1300
2513234	GED7042100S					2100

227 E
RUBBER MALLET soft
 DIN 5128-60, 60 Shore A
 With two flat surfaces
2 A with one curved and one flat surface
 With ash handle



Code	No.	mm	mm	mm	mm	
8826660	227 E-0	80	260	40	150	6
8826740	227 E-1	90	320	55	320	6
8826820	227 E-2	115	340	65	540	6
8826900	227 E-2 A	115	340	65	430	6
8827040	227 E-3	130	380	75	770	6
8827120	227 E-4	140	380	90	1050	6

GED705
DRIFT PUNCH
 With hickory handle



Code	No.	mm	
2513773	GED7050800S	8	800
2513196	GED7051800S	10	800
2513226	GED7051200S	12	1200
2513188	GED7052200S	16	1200

228
WOODEN MALLET
 Made from white beech wood
 Acc. to DIN 7462 A



Code	No.	mm	mm	mm	
8828010	228-60	300	60	350	6
8828280	228-70	340	70	470	6

RECOILLESS HAMMERS NON-SPARKING

i Recoilless hammers

- All **Power Drive**® recoilless hammers are made in the USA with Nuplaglas® fibre glass handles.
- The patented, impact-resilient compound material of the inner cavities is enveloped in an extremely robust polymer protective jacket.
- Compared to other hammers of this type, this results in a 40 % rise in impact power and a reduction of recoil.
- The specially designed impact surface material ensures an extremely high level of surface protection and unbelievable durability.
- In order that a non-sparking version is involved, brass surfaces are also available.

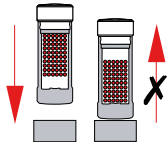

226 E
RUBBER MALLET hard
 DIN 5128-90, 90 Shore A
 With two flat surfaces
2 A with one curved and one flat surface
 With ash handle



Code	No.	mm	mm	mm	mm	
8825500	226 E-0	80	260	40	210	6
8825690	226 E-1	90	320	55	370	6
8825770	226 E-2	115	340	65	630	6
8825850	226 E-2 A	115	340	65	578	6
8825930	226 E-3	130	380	75	990	6
8826070	226 E-4	140	380	90	1460	6

GEDSFN
RECOILLESS HAMMER
 With Nuplaglas® fibreglass handle



Code	No.	mm	
2495341	GEDSFN1SG	40	800
2521431	GEDSFN2SG	50	1000
2521423	GEDSFN3SG	60	1300
2521415	GEDSFN4SG	70	1600

GEDSDS

RECOILLESS HAMMER with non-sparking striking face

With Nuplaglas® fibreglass handle



Code	No.	Ø mm	mm
2511509	GEDSDSFB-2SG	50	1000

GEDSTPN

RECOILLESS HAMMER with fixed plastic caps

With Nuplaglas® fibreglass handle



Code	No.	Ø mm	mm
2495333	GEDSTPN16	16	450
2495325	GEDSTPN24	24	675

GEDSPI

NON-SPARKING HOLDER without cap

With Nuplaglas® fibreglass handle



Code	No.	Ø mm	mm
2521407	GEDSPI106N	25	350
2521393	GEDSPI156N	40	500
2516691	GEDSPI206N	50	1000
2516683	GEDSPI256N	65	2000
2516675	GEDSPI306N	75	3000

GEDSPS

PLASTIC HAMMER without cap

With Nuplaglas® fibreglass handle



Code	No.	Ø mm	mm
2511371	GEDSPS105N	25	250
2511266	GEDSPS150N	40	450
2511142	GEDSPS155N	40	300
2511002	GEDSPS200N	50	700
2494515	GEDSPS205N	50	1000
2494396	GEDSPS250N	65	1150
2494272	GEDSPS255N	65	1950
2494159	GEDSPS300N	75	1500
2494035	GEDSPS305N	75	3000
2493918	GEDSPS306N	75	3400
2493780	GEDSPS307N	75	3700



soft



medium soft



medium hard



hard



hard



extra hard



Brass

GED10

CAPS 25 MM Ø for SPI106N, SPS105N

Code	No.	Ø mm	Hardness	mm
2514443	GED10H-N	25	hard	40
2514427	GED10M-N	25	medium hard	40
2514893	GED10S-N	25	soft	40
2513765	GED10SN-N	25	medium soft	40
2502798	GED10T-N	25	hard	40
2511983	GED10XH-N	25	extra hard	40

GED15

CAPS 40 MM Ø for SPS150N, SPS155N, SPI156N

Code	No.	Ø mm	Hardness	mm
2513463	GED15B-N	40	Brass	40
2514907	GED15H-N	40	hard	40
2509547	GED15M-N	40	medium hard	40
2505509	GED15S-N	40	soft	40
2505770	GED15SN-N	40	medium soft	40
2514885	GED15T-N	40	hard	40
2509520	GED15XH-N	40	extra hard	40

GED20

CAPS 50 MM Ø for SPS200N, SPS205N, SPI206N

Code	No.	Ø mm	Hardness	mm
2513269	GED20B-N	50	Brass	130
2514877	GED20H-N	50	hard	90
2509490	GED20M-N	50	medium hard	90
2514478	GED20S-N	50	soft	90
2505568	GED20SN-N	50	medium soft	100
2514869	GED20T-N	50	hard	100
2509482	GED20XH-N	50	extra hard	100

GED25				
CAPS 65 MM Ø for SPS250N, SPS255N, SPI256N				
Code	No.	Ø mm	Hardness	↕
2502771	GED25H-N	65	hard	70
2516802	GED25M-N	65	medium hard	70
2507536	GED25S-N	65	soft	70
2516721	GED25SN-N	65	medium soft	70
2505525	GED25T-N	65	hard	70
2505495	GED25XH-N	65	extra hard	70

GED30				
CAPS 75 MM Ø for SPS305N, SPS307N, SPI306N				
Code	No.	Ø mm	Hardness	↕
2514850	GED30H-N	75	hard	240
2509474	GED30M-N	75	medium hard	240
2514451	GED30S-N	75	soft	270
2505541	GED30SN-N	75	medium soft	270
2514842	GED30T-N	75	hard	280
2509466	GED30XH-N	75	extra hard	310

CHISELS NON-SPARKING

GED115				
FLAT COLD CHISEL flat oval				
▶ Cutting edge free of burrs				
Code	No.	↳ mm	mm	↕
2522292	GED1150150S	150	20	200
2522284	GED1150200S	200	25	320
2522276	GED1150250S	250	25	550
2522268	GED1150300S	300	25	560
2522241	GED1150400S	400	30	630
2522225	GED1150450S	450	30	750
2522217	GED1150500S	500	30	920

GED115				
SPLITTING CHISEL flat				
▶ Cutting edge free of burrs				
Code	No.	↳ mm	mm	Height
2498979	GED1150001S	200	25	5
2498960	GED1150002S	250	25	5
2498952	GED1150003S	300	25	5

GED709				
BRICKLAYER'S CHISEL hexagon				
▶ Similar to DIN 7254				
▶ Cutting edge free of burrs				
Code	No.	↳ mm	mm	↕
2495511	GED7090006S	200	6	35
2521938	GED7090008S	150	8	40
2521911	GED7090010S	150	10	120
2521903	GED7090014S	150	14	200
2521792	GED7090200S	200	14	250
2521784	GED7090250S	250	14	300
2521814	GED7090140S	300	14	400
2521881	GED7090017S	150	17	300
2521806	GED7090170S	250	17	450
2521776	GED7090300S	300	17	550

Code	No.	↳ mm	mm	↕
2521873	GED7090020S	200	19	500
2521946	GED7090002S	250	19	600
2521768	GED7090350S	350	19	850
2521725	GED7090400S	400	19	1000
2521849	GED7090023S	250	22	850
2521857	GED7090022S	300	22	1000
2521717	GED7090500S	500	22	1600
2521709	GED7090600S	600	22	2000
2521830	GED7090027S	250	27	580
2521822	GED7090050S	300	32	850

GED116				
CROSS-CUT CHISEL oval				
▶ Cutting edge free of burrs				
Code	No.	↳ mm	mm	↕
2522209	GED1160150S	150	8	250
2522195	GED1160200S	200	8	340
2522187	GED1160250S	250	8	480
2522179	GED1160300S	300	10	640

GED710				
CROSS-CUT CHISEL hexagon				
▶ Cutting edge free of burrs				
Code	No.	↳ mm	mm	↕
2502720	GED7100200S	200	14	270
2502712	GED7100250S	250	14	330
2502704	GED7100300S	300	17	550
2502682	GED7100400S	400	19	960

GED708				
POINT CHISEL hexagon				
Code	No.	↳ mm	mm	↕
2502763	GED7080200S	200	14	270
2502755	GED7080250S	250	14	330
2502747	GED7080300S	300	17	550
2502739	GED7080400S	400	19	960

GED711				
CONCRETE CHISEL				
Code	No.	↳ mm	Height	↕
2513757	GED7110380S	380	45	5000

108 UNI

PROTECTIVE HAND GUARD

- Made from PVC
- Improved protective plate offers highest safety for the hand against impacts
- Ergonomic design
- Avoids injuries of the hand
- No rolling away (elliptical-shaped)
- Jarring blows do not move into the hand
- No fatigue of the hand - optimum hold
- All chisels from 250 mm length can be supplied with universal protective hand guard (HS)
- DBGM (German utility patent)



product
design
award

2008

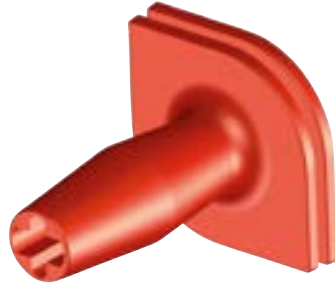
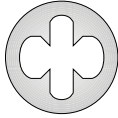

Code	No.	oval	octagonal	mm	mm
8658500	108 UNI	20 x 12 23 x 13 26 x 13 26 x 7	14 16 18 20	182	1

GED118

DRIFT PUNCH conical

- Similar to DIN 6458



Code	No.	L	s	d	mm
2503026	GED1180010S	120	1	8	35
2503018	GED1180020S	120	2	8	35
2502992	GED1180030S	120	3	8	35
2502984	GED1180040S	120	4	8	40
2502976	GED1180050S	120	5	10	60
2502968	GED1180060S	120	6	10	60
2502941	GED1180070S	120	7	10	65
2502925	GED1180080S	120	8	10	65
2502917	GED1180090S	150	9	13	135
2498855	GED1180100S	150	10	13	140
2498847	GED1180120S	160	12	16	220
2498839	GED1180140S	160	14	16	230
2498820	GED1180160S	200	16	20	500
2498812	GED1180180S	200	18	20	500
2498804	GED1180200S	200	20	24	620
2498790	GED1180220S	200	22	24	640

PIN / DRIFT PUNCHES NON-SPARKING

GED120

SCRIBER



Code	No.	mm	Ø	mm
2514974	GED1201900S	190	4	50
2514966	GED1202250S	225	6	50

GED118

DRIFT PUNCH conical, strong version



Code	No.	L	s	d	mm
2515164	GED1180011S	150	6	13	100
2515040	GED1180012S	150	7	17	100
2514923	GED1180013S	200	8	21	395
2496844	GED1180014S	250	12	24	645
2516942	GED1180130S	250	13	30	865

GED195

OFFSET PIN



Code	No.	L	W	Ø	mm
2495643	GED1950300S	300	100	13	200
2495635	GED1950400S	450	150	19	1300
2495619	GED1950401S	450	150	16	930
2495600	GED1950402S	450	150	24	2000
2495597	GED1950403S	450	150	27	2300
2495589	GED1950404S	450	150	30	3300
2495570	GED1950405S	500	150	16	1300
2495562	GED1950406S	600	200	20	2400
2495554	GED1950407S	800	200	22	3400

GED118

DRIFT PUNCH conical, extra strong version



Code	No.	L	s	d	mm
2522160	GED1180500S	220	5	16	255
2496712	GED1181000S	230	10	19	420
2532921	GED1180015S	250	13	24	880

GED081

SQUARE BLADED AWL



Code	No.	mm	mm
2512505	GED0810060S	100	80

GED118

DRIFT PUNCH spindle-shaped



Code	No.	L	s	d	mm
2505843	GED1180004S	200	8	17	230
2505835	GED1180005S	200	8	21	360
2503077	GED1180006S	200	10	24	415
2503050	GED1180007S	200	13	27	630
2503042	GED1180008S	200	18	30	880
2503034	GED1180009S	200	22	32	1050

GED117
CENTRE PUNCH



Code	No.	(mm)	s	d	40
2495856	GED1170100S	100	3		30
2495848	GED1170110S	110	4		60
2495821	GED1170125S	125	5		100
2495813	GED1170150S	150	6		200

GED118
DRIFT PUNCH SET 6 pieces
In plastic holder



Code	No.	Contents	40
2507552	GED1180001S	1 drift punch each 1 2 3 4 5 mm 1 centre punch 4 mm	310

GED119
PIN PUNCH
Similar to DIN 6450



Code	No.	(mm)	s	d	40
2509741	GED1190150S	110	1.5	10	45
2512491	GED1190200S	110	2.0	10	50
2512483	GED1190300S	110	3.0	10	45
2512467	GED1190400S	120	4.0	10	50
2512459	GED1190500S	130	5.0	10	50
2512440	GED1190600S	140	6.0	10	60
2512432	GED1190800S	150	8.0	12	100
2511800	GED1191000S	160	10.0	12	120
2511797	GED1191300S	180	13.0	16	240
2511789	GED1191600S	200	16.0	16	400

GED119
PIN PUNCH strong version



Code	No.	(mm)	s	d	40
2522144	GED1191500S	150	6	14	120
2516918	GED1190100S	180	10	14	160
2516926	GED1190013S	200	13	18	290
2516896	GED1190160S	300	16	20	655

GED162
TAPER PUNCH



Code	No.	(mm)	s	d	40
2512378	GED1620500S	500	5	20	1200

GED118
PIN PUNCH SET 6 pieces
In plastic holder



Code	No.	Contents	40
2498863	GED1180002S	1 pin punch each 3 4 5 6 8 10 mm	440

GED120
DRIFT PIN
Similar to DIN 6459



Code	No.	(mm)	d	40
2515547	GED1200008S	85	8	40
2515431	GED1200010S	90	10	50
2515423	GED1200013S	100	13	70
2515415	GED1200016S	110	16	100
2515393	GED1200019S	140	19	180
2515385	GED1200021S	160	21	270
2515377	GED1200025S	200	25	450
2515369	GED1200029S	240	29	630

GED120
SETTING PUNCH



Code	No.	(mm)	s	d	40
2515016	GED1200005S	180	5	12	110
2515008	GED1200006S	200	6	13	150
2514982	GED1200080S	200	8	16	220
2514990	GED1200095S	200	9	20	340
2514648	GED1200100S	230	10	22	460
2514699	GED1200011S	250	11	25	620
2514680	GED1200012S	280	12	27	870
2514664	GED1200014S	320	14	30	1260
2514656	GED1200015S	350	15	32	1570
2514621	GED1200160S	380	16	36	2230

GED136
THREAD CLEANING PIN



Code	No.	(mm)	Ø	40
2514559	GED1360006S	300	6	75
2496593	GED1360007S	300	10	180
2496461	GED1360008S	300	13	350

KNIVES, S



GRADERS

KNIVES, SCRAPERS NON-SPARKING

*funkenfrei



KNIVES, SCRAPERS NON-SPARKING

GED190

YARNING CHISEL/YARNING TOOL



Code	No.	Width	mm
2512955	GED1900002C	2	370
2512831	GED1900003C	3	410
2512726	GED1900004C	4	390
2512599	GED1900005C	5	520
2512475	GED1900006C	6	420
2512351	GED1900007C	7	500
2512238	GED1900008C	8	520
2512106	GED1900009C	9	520
2495007	GED1900010C	10	525
2494884	GED1900012C	12	540

GED073

KNIFE

- ▣ With sturdy and fixed blade
- ▣ With wooden handle



Code	No.	mm	mm	mm
2515458	GED0731800C	80	180	75

GED073

KNIFE reinforced version

- ▣ With sturdy and fixed blade
- ▣ With wooden handle



Code	No.	mm	mm	mm
2517256	GED0731801S	200	300	300

GED139

SCRAPER flexible



Code	No.	L	W	mm
2505827	GED1390040C	210	40	75
2505819	GED1390050C	210	50	80
2505800	GED1390060C	210	60	95
2505797	GED1390080C	230	80	90
2505789	GED1390090C	230	90	115
2502844	GED1390100C	230	100	125

GED140

SCRAPER rigid



Code	No.	L	W	mm
2509636	GED1400030S	210	30	110
2509628	GED1400040S	220	40	120
2509601	GED1400050S	220	50	150
2509598	GED1400060S	220	60	165
2509571	GED1400080S	240	80	190
2509563	GED1400090S	240	90	215
2507544	GED1400100S	240	100	240

GED723

SCRAPER flexible



Code	No.	L	W	mm
2521652	GED7230000C	175	78	125

GED999
SPATTLE



Code	No.	mm	Blade length	Blade width	
2511630	GED9991052S	260	150	25	85
2511614	GED9991053S	350	230	40	145
2511606	GED9991054S	490	355	50	275

GED138
FLAT SCRAPER

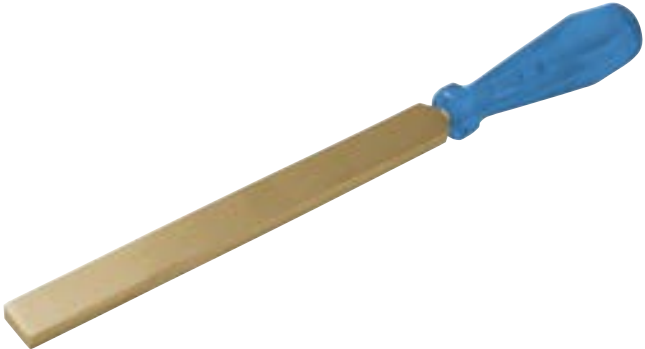

Code	No.	mm	mm	mm
2513544	GED1380200S	200	310	290

GED136
ANGLED SCRAPER



Code	No.	L	W	
2512416	GED1360200S	200	22	210
2512408	GED1360255S	255	45	480
2512394	GED1360300S	300	50	570

GED137
THREE-SQUARE SCRAPER



Code	No.	mm	mm	mm
2509644	GED1372000S	200	310	220

GED136
ANGLED SCRAPER WITH HANDLE



Code	No.	L	W	
2516829	GED1360380S	380	38	780

GED135
TRIANGULAR SHIP SCRAPER



Code	No.	mm	mm	mm
2516837	GED1355000S	420	100	70
				650

GED714
SPRAY BOOTH SCRAPER

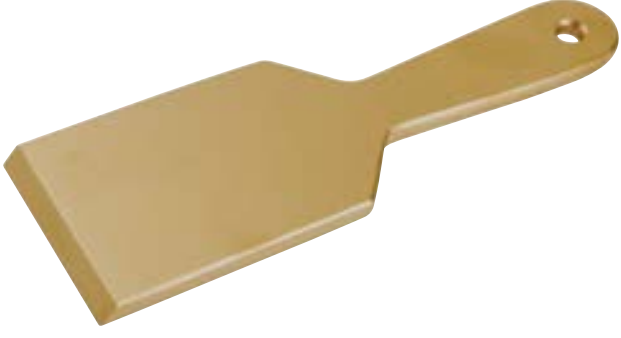

Code	No.	mm	
2495481	GED7140001S	235	450

GED715

SCRAPER WITH HANDLE



Code	No.	L	W	→
2498685	GED7150001S	480	95	620

GED133

RUST SCRAPER

► With handle



Code	No.	L	W	→
2516888	GED1330600S	600	75	530
2516845	GED1330800S	800	75	620
2514818	GED1331000S	1000	75	740
2514672	GED1331200S	1200	75	1160

GED131

SCRAPER

► On request with handle



Code	No.	L	W	→
2515350	GED1310750S	220	75	580
2515202	GED1311000S	220	100	830
2515199	GED1311250S	220	125	880
2515180	GED1311500S	220	150	1020

GED139

TROWEL



Code	No.	(mm)	Blade width	Blade length	→
2514028	GED1390130S	335	130	215	350
2514001	GED1390135S	360	135	240	540

GED132

DISHED SCRAPER

► On request with handle



Code	No.	L	W	→
2511762	GED1321000S	240	100	900
2511746	GED1321500S	240	150	1350

GED139

SMOOTHING TROWEL



Code	No.	Blade length	Blade width	→
2514591	GED1390280S	280	120	810

GED139
POINTING TROWEL



Code	No.	Blade width	
2514605	GED13901605	160	180

GED134
CLEANING TOOL



Code	No.	mm	
2502852	GED13448005	480	1200

GED139
FILLING TROWEL



Code	No.	Blade width	
2514958	GED13900105	10	113

GED134
FLOOR SCRAPER



Code	No.	L	W	
2509652	GED13415005	170	150	720

GED723
BROAD TROWEL rigid blade



Code	No.	L	W	
2498650	GED72300125	195	120	250
2498642	GED72300145	195	140	270
2498634	GED72300165	205	160	300
2502666	GED72300185	205	160	350

GED131
SHIP SCRAPER



Code	No.	L	W	
2512424	GED13100755	150	75	500
2511770	GED13101255	235	125	800

BRUSHES,



SCOURERS

BRUSHES, SCRUBBERS NON-SPARKING



SPARKING

*funkenfrei

BRUSHES, SCRUBBERS NON-SPARKING

GED176

BRUSH tin bronze wire, crimped



Code	No.	L	W	↕
2511665	GED17618005	180	70	300

GED175

WIRE BRUSH tin bronze wire, crimped



Code	No.	Rows	↳mm↳	↕
2511703	GED1750030S	3	350	190
2511681	GED1750040S	4	350	210
2511673	GED1750050S	5	350	190

GED175

HAND BRUSH tin bronze wire, crimped



Code	No.	Rows	↳mm↳	↕
2512335	GED1750008S	3	290	110
2512327	GED1750009S	4	290	130
2512319	GED1750010S	5	290	150

GED175

HAND BROOM tin bronze wire, crimped

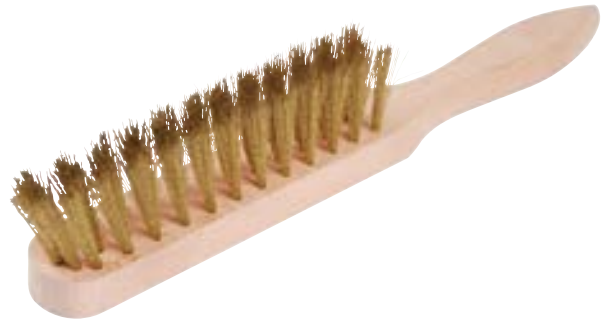

Code	No.	↳mm↳	↕
2505754	GED1750007S	310	320

GED175

SCRUBBER

▣ On request with handle



Code	No.	Measurements (mm)	↕
2509512	GED1752450S	245x65x40	480

GED175

BROOM round wire, straight

▣ With handle



Code	No.	Measurements (mm)	↕
2502836	GED1753000S	300x70x100	1500

GED121
SQUEEGEE
 ▾ Wooden, with handle



Code	No.	mm	mm
2502909	GED12107355	600	300

GED175
BRUSH wire, crimped



Code	No.	Ø	Shaft height	Shaft Ø
2495678	GED1750065	26	25	6

GED176
SPARK PLUG BRUSH round wire, straight



Code	No.	mm	mm
2522039	GED17619005	145	25

GED177
ROUND BRUSH tin bronze wire, crimped



Code	No.	Hole Ø	Ø	mm
2498758	GED17701505	22.2	150	520

GED179
CYLINDER BRUSH wire, crimped



Code	No.	mm	mm
2522020	GED17903205	300	42

GED178
CUP BRUSH tin bronze wire, crimped



Code	No.	Hole Ø	Ø	mm
2498731	GED17801505	22.2	125	700



HATCHETS



SHOVELS

HATCHETS, SHOVELS, SPADES, FORKS NON-SPARKING



*funkenfrei

HATCHETS, SHOVELS, SPADES, FORKS NON-SPARKING

GED716

HOE
 With beech handle



Code	No.	mm	mm	
2515555	GED7160001S	950	120	2300

GED145

HATCHET
 With hickory handle



Code	No.	mm	
2515539	GED1451000S	450	1300
2515512	GED1451500S	450	1500

GED146

AXE
 With hickory handle



Code	No.	mm	
2515571	GED1467500S	750	1600
2515563	GED1469000S	900	2200

GED717

FIREFIGHTER'S AXE
 With hickory handle
 Similar to DIN 14900



Code	No.	mm	
2513129	GED7170000S	800	2600

GED145

FIREFIGHTER'S HATCHET
 With fibreglass handle



Code	No.	mm	
2522071	GED1450900C	400	900

GED717

HAND PICK



Code	No.	L	W	
2514419	GED7170001S	380	225	1000

GED719

MINER'S PICK
 On request with beech handle



Code	No.	mm	
2513110	GED7190001S	400	2200

GED718

FIREMAN'S HOOK
 Similar to DIN 14851
 Without handle



Code	No.	L	W	
2512165	GED7180001S	380	176	1800

GED125
PICKAXE
 With beech handle
 Similar to DIN 20109



Code	No.	L	W	
2495783	GED1255801S	800	400	2150
2495775	GED1255802S	950	500	3500
2495791	GED1255800S	950	550	4000

GED152
FOLDING SPADE
 With beech handle



Code	No.	Blade length	Blade width	\pm mm	
2509555	GED1521260S	320	180	740	1300

GED126
PICKAXE
 With beech handle



Code	No.	L	W	
2514613	GED1265600S	950	650	4100

GED153
SHOVEL, FRANKFURT PATTERN
 With beech handle



Code	No.	Blade length	Blade width	\pm mm	Handle type	
2495694	GED1531250S	340	260	1400	straight	1850
2522055	GED1531251S	340	260	1150	D	1850

GED152
SPADE
 With beech handle



Code	No.	Blade length	Blade width	\pm mm	Handle type	
2514931	GED1521160S	260	180	1250	T	3500
2514915	GED1521161S	260	180	1250	D	3650



GED150

SHOVEL

With beech handle



Code	No.	Blade length	Blade width	↳mm↳	Handle type	↳mm↳
2498774	GED1501280S	400	270	1400	straight	1950
2512386	GED1501281S	400	270	1150	D	1950

GED151

MANURE FORK

With beech handle



Code	No.	Blade length	Blade width	↳mm↳	↳mm↳
2516810	GED1511600S	330	230	1600	1640

GED151

HAND SHOVEL

With beech handle



Code	No.	Blade length	Blade width	↳mm↳	↳mm↳
2513536	GED1510540S	220	180	540	720

GED151

SPADE FORK

With beech handle



Code	No.	Blade length	Blade width	↳mm↳	Handle type	↳mm↳
2496348	GED1511000S	290	180	1000	D	1265



GED151
HAY FORK
 With beech handle



Code	No.	Blade length	Blade width	↳mm↳	↕
2522063	GED1511100S	290	180	1600	1280

GED151
RAKE
 With beech handle



Code	No.	L	W	↳mm↳	↕
2498766	GED1511200S	1600	360		1530

GED151
FORK FOR GUNCOTTON
 On request with beech handle



Code	No.	Blade length	Blade width	↳mm↳	↕
2519429	GED1511300S	140	90	200	600
2519305	GED1511400S	250	150	370	1305

GED000
SICKLE



Code	No.	↳mm↳	↕
2515466	GED0001002S	250	800



GED000
HEDGE SHEARS



Code	No.	Blade length	↳mm↳	↕
2513722	GED0001001C	300		1400

WEDGES,



*funktionsfrei



CROWBAR

WEDGES, CROWBARS NON-SPARKING



WEDGES, CROWBARS NON-SPARKING

GED186

FLANGE WEDGE

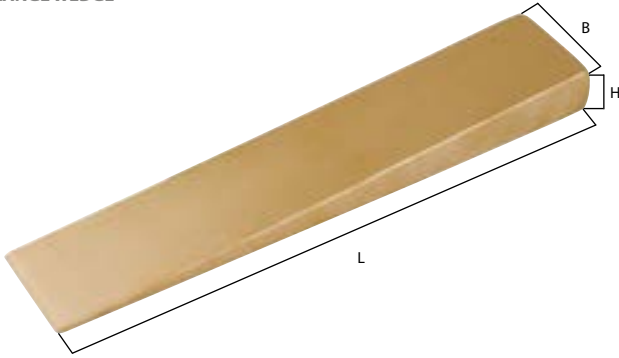

Code	No.	L	W	H	mm±
2509504	GED1860010S	80	15	6	40
2507528	GED1860011S	90	50	10	200
2505746	GED1860001S	100	50	10	210
2505673	GED1860006S	105	19	13	100
2505738	GED1860002S	150	25	13	215
2505711	GED1860003S	150	30	13	280
2505665	GED1860007S	150	38	19	400
2505703	GED1860004S	150	40	13	425
2505622	GED1860012S	180	32	13	300
2505614	GED1860013S	180	50	10	400
2505657	GED1860008S	180	50	19	700
2505606	GED1860014S	200	38	25	900
2505592	GED1860015S	200	38	41	1300
2505649	GED1860009S	200	40	40	1380
2505584	GED1860016S	200	50	19	800
2505576	GED1860017S	215	50	32	1400
2505681	GED1860005S	230	40	20	1000

GED185

WEDGE with hole

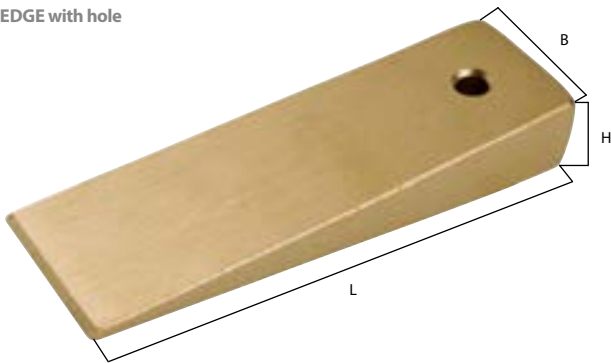

Code	No.	L	W	H	Hole Ø	mm±
2498715	GED1851000S	100	30	15	6	220



GED186

SPACE CHISEL

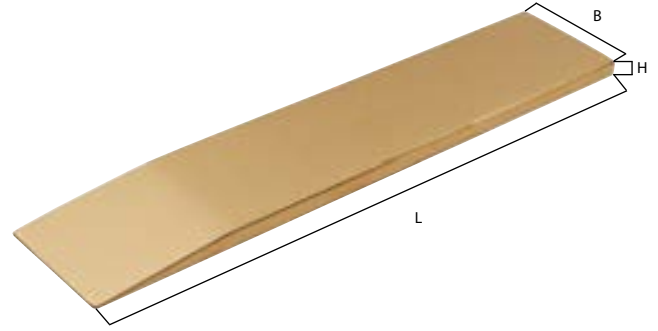

Code	No.	L	W	H	mm±	mm±
2495651	GED1861002S	250	50	5	1.5	200

GED186

GIB-HEAD KEY

For positive joint between shaft and hub.

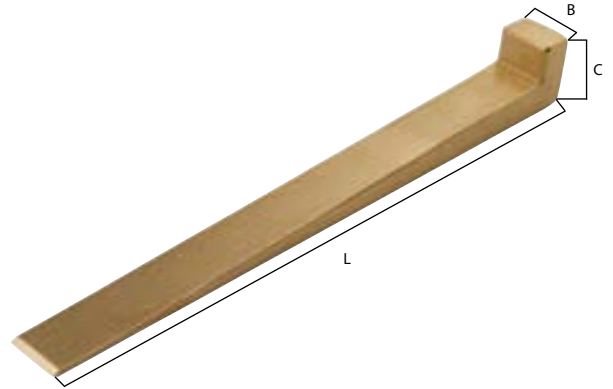

Code	No.	L	W	H	Shaft width	Shaft height	mm±
2521466	GED9991034S	340	20	40	20	20	2600
2521989	GED1861001S	340	30	40	20	20	2800
2522004	GED1861000S	400	30	40	40	15	3500

GED712

STONE WEDGE

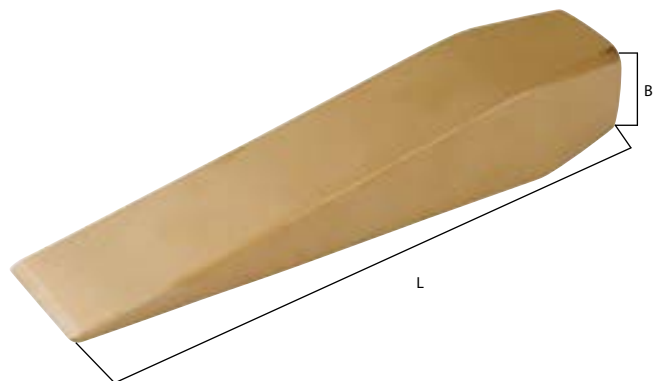

Code	No.	L	W	mm±
2513161	GED7120001S	120	44	1100
2513153	GED7120002S	150	45	1400
2513145	GED7120003S	190	47	2000
2513137	GED7120004S	240	50	3000

GED720
FLANGE KNIFE straight, with mandrel

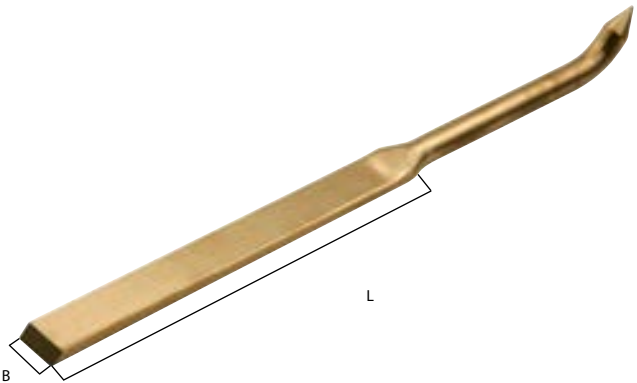

Code No. (mm) (mm) Blade length (mm)

2495473	GED7200001S	400	25	220	300
---------	--------------------	-----	----	-----	-----

GED161
CROWBAR



Code No. (mm) (mm) (mm)

2513935	GED1613000S	300	14	400
2513927	GED1614500S	450	19	1100
2513919	GED1616000S	600	19	1500
2513900	GED1617500S	750	22	2500
2513897	GED1619000S	900	22	3000

GED720
FLANGE KNIFE round



Code No. (mm) (mm) Blade length (mm) (mm)

2495465	GED7200002S	690	30	400	1200
2521695	GED7200003S	1240	40	800	2000

GED160
CROWBAR



Code No. (mm) (mm) (mm)

2513994	GED1600450S	450	19	1100
2513986	GED1600600S	600	19	1500
2513978	GED1600750S	750	22	2500
2513951	GED1600900S	900	22	3000
2513455	GED1601000S	1000	22	3300
2513439	GED1601250S	1250	27	6100
2513420	GED1601500S	1500	27	7300
2513412	GED1601800S	1800	30	11100
2513404	GED1602000S	2000	30	12300

GED161
WRECKING BAR



Code No. (mm) (mm) (mm)

2513706	GED1610300S	300	14	400
2513587	GED1610450S	450	9	1100
2513447	GED1610600S	600	19	1500
2513323	GED1610750S	750	22	2500
2513218	GED1610900S	900	22	3000

GED160
CROWBAR with point and cutting edge



Code No. (mm) (mm) (mm)

2514435	GED1600001S	1000	30	6150
2514311	GED1600002S	1250	30	7700
2514192	GED1600003S	1500	30	9250
2514079	GED1600004S	1800	30	11100
2513943	GED1600005S	2000	30	12300

GED160

CROWBAR with point and claw



Code	No.	(mm)	Ø	↕
2496224	GED1600006S	1000	30	6150
2496100	GED1600007S	1250	30	7700
2495988	GED1600008S	1500	30	9250
2495864	GED1600009S	1800	30	11100
2495740	GED1600010S	2000	30	12300

GED160

CROWBAR with cutting edge and ball



Code	No.	(mm)	Ø	↕
2516799	GED1600011S	1000	30	6150
2516780	GED1600012S	1250	30	7700
2516772	GED1600013S	1500	30	9250
2516764	GED1600014S	1800	30	11100
2516756	GED1600015S	2000	30	12300

GED160

CROWBAR with point and ball



Code	No.	(mm)	Ø	↕
2495627	GED1600016S	1000	30	6150
2495503	GED1600017S	1250	30	7700
2495384	GED1600018S	1500	30	9250
2495260	GED1600019S	1800	30	11100
2495120	GED1600020S	2000	30	12300

GED162

LIFTING ROD



Code	No.	(mm)	■	↕
2514583	GED1620650S	650	20	2000
2514575	GED1620800S	800	20	2700
2513889	GED1621000S	1000	20	3400
2513870	GED1621250S	1250	25	6200
2513862	GED1621500S	1500	25	7700

GED163

BENDING BAR



Code	No.	L	s	↕	
2513331	GED1632000S	200	5	19	660
2513315	GED1633000S	300	5	19	1000
2513307	GED1634000S	400	5	19	1300
2513293	GED1635000S	500	5	19	1600
2513285	GED1636000S	600	5	19	2000

GED163

TYRE LEVER



Code	No.	(mm)	↕
2513390	GED1630200S	200	350
2513382	GED1630305S	300	470
2513374	GED1630400S	400	600
2513366	GED1630500S	500	770
2513358	GED1630600S	600	900

GED163
TYRE LEVER heavy-duty, offset pattern



Code	No.	↳mm↳	↕↔
2495686	GED1630610S	600	1000

GED020
CARBIDE DRUM OPENER



Code	No.	↳mm↳	↕↔
2499797	GED0203000S	300	750

GED724
CRATE OPENER



Code	No.	↳mm↳	↕↔
2509423	GED7240001S	230	455

GED092
BARREL HOOK



Code	No.	↳mm↳	max. kg	↕↔
2514710	GED0920600S	1060	600	3800

OTHER HA

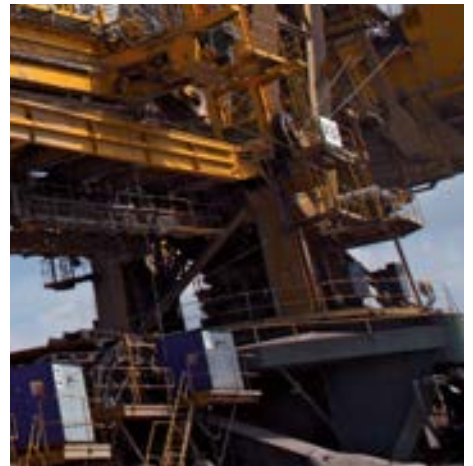

HAND TOOLS

OTHER HAND TOOLS NON SPARKING



*funktionsfrei

OTHER HAND TOOLS NON-SPARKING

GED110

HACKSAW

▣ For sawblade length 300 mm



Code	No.	↳mm↳	↕
2515024	GED1100680S	560	900

GED111

SAWBLADE FOR HACKSAW



Code	No.	↳mm↳	↕
2515288	GED1110300C	300	30

GED110

HAND SAW



Code	No.	↳mm↳	↕
2515105	GED1100681C	370	500

GED999

HAND SAW



Code	No.	↳mm↳	↕
2495376	GED9991024C	700	770

GED771

PIPE CUTTER



Code	No.	↳mm↳	up to Ømm	↕
2509407	GED7710000S	430	50	2500

GED180

SCREW CLAMP

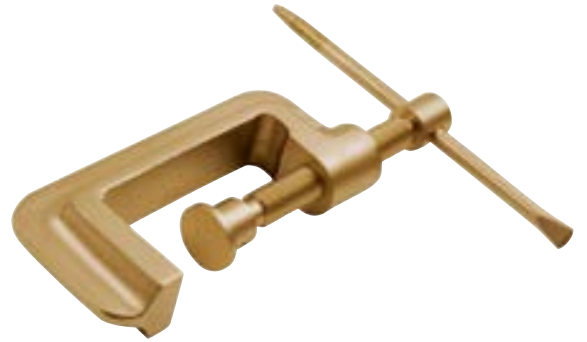

Code	No.	↳mm↳	mmØ	↕
2512300	GED1800180S	180	80	3160
2512297	GED1800250S	250	120	4230
2512289	GED1800430S	430	270	13500

GED180

SCREW CLAMP



Code	No.	↳mm↳	mmØ	↕
2498723	GED1800001S	480	130	2100

GED180
SCREW CLAMP WITH DEEP REACH



Code	No.	mm	mm	
2513080	GED1800002S	480	250	3700

GED156
PARALLEL VICE

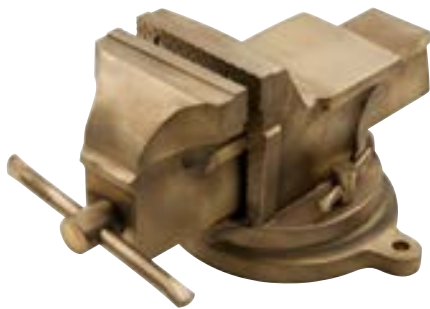

Code	No.	mm	mm	
2513528	GED1560090S	90	100	6500
2513501	GED1560125S	125	130	15500
2513498	GED1560150S	150	150	26500
2513471	GED1560170S	170	170	27400

GED721
BUCKET



Code	No.	Litre	Material	
2509431	GED7210001S	10	Brass	1460
2505533	GED7210002S	12	Aluminium	740

GED170
FLAT FILE



Code	No.	mm	Cut	
2513854	GED1701265C	265	1	330
2513846	GED1703265C	265	3	330

GED171
HALF-ROUND FILE



Code	No.	mm	Cut	
2511738	GED1711260C	260	1	340
2511711	GED1713260C	260	3	340

GED172
ROUND FILE



Code	No.	mm	Cut	
2514567	GED1721260C	260	1	175
2514540	GED1723260C	260	3	175

GED211
POCKET VERNIER CALLIPER
 ▽ Brass model
 ▽ Graduated in mm, vernier 1/20



Code	No.	mm	
2502801	GED2110000S	150	165

SPECIALI



TIES

SPECIALITIES NON-SPARKING

*funkenfrei
SPARKING



SPECIALITIES NON-SPARKING

GED181

SHACKLE



Code	No.	Measurements	↕
2514524	GED1810002C	30 x 40	100
2514516	GED1810003C	37 x 78	150

GED999

SAFETY RING FOR HAMMERS



Code	No.	Use
2516713	GED9991016S	> 2 kg
2516705	GED9991017S	2 - 6 kg

GED181

HEARING NEEDLE



Code	No.	↳mm↵	∅	↕
2514508	GED1810006C	250	6	85
2514494	GED1810007C	300	8	150
2514486	GED1810008C	400	7	160
2513811	GED1810009C	500	10	335

GED181

HEARING NEEDLE WITH BALLHEAD



Code	No.	↳mm↵	∅	↕
2522012	GED1810005C	500	6	130

GED181

NEEDLES



Code	No.	↳mm↵	∅	↕
2515091	GED1810004C	180	3	15

GED073

PLASTIC TWEEZERS



Code	No.	↳mm↵	↕
2499096	GED0731110S	100	15

GED073

TWEEZERS POINTED



Code	No.	↳mm↵	↕
2511819	GED0731111S	150	30

GED073

TWEEZERS EDGELESS



Code	No.	↳mm↵	↕
2510154	GED0731112S	100	30

GED186

FLANGE SPREADER



Code	No.	a	b	c	d	↳mm↵	↕
2513277	GED1860018S	60	60	40	46	300	7200

GED724

DRAWING KNIFE

► For reworking and fitting squared timber and de-barking tree trunks

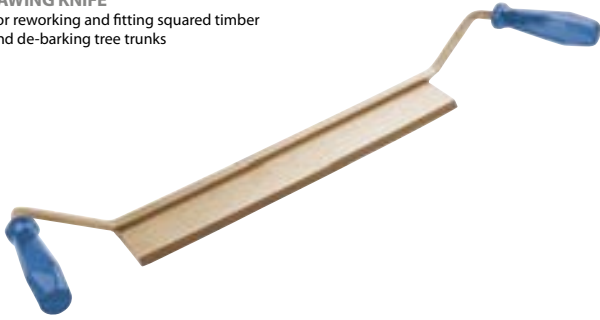

Code	No.	↳mm↳	Cutting width	↕
2514834	GED7240004S	650	250	1500

GED999

TWIST DRILL SET 15 pieces



Code	No.	Contents	↕
2513730	GED9991075C	6 / 7 / 8 / 9 / 10 / 11 / 12 / 13 / 14 / 15 / 16 / 17 / 18 / 19 / 20 mm	4000

GED999

PORTABLE, HAND-OPERATED OIL PUMP



Code	No.	↳mm↳	↕
2495368	GED9991057S	1350	5000

GED999

FORKLIFT

► Loading capacity app. 2000 kg
 ► Fork length app. 1100 mm
 ► Length guiding rod app. 1250 mm

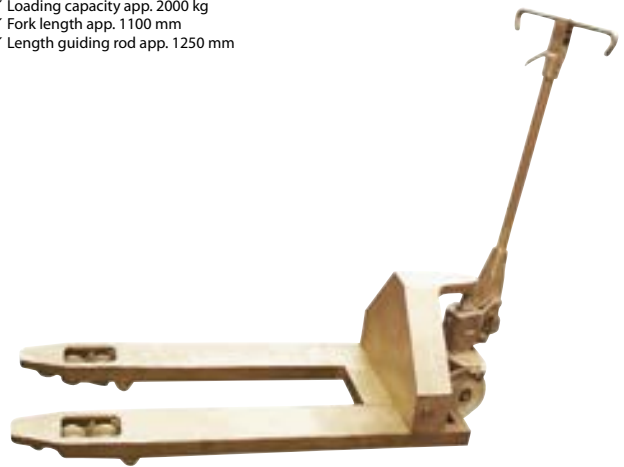

Code	No.	↕
2515598	GED9991081S	12000

GED999

PULLEY



Code	No.	Execution	max. t	↕
2521482	GED9991018S	2 chains each 2.5 m	0.5	10200
2495406	GED9991019S	2 chains each 2.5 m	1.0	13600
2521474	GED9991020S	2 chains each 2.5 m	1.5	15600
2495392	GED9991021S	2 chains each 2.5 m	2.0	22000
2502593	GED9991022S	2 chains each 3 m	3.0	23600
2502585	GED9991023S	2 chains each 3 m	5.0	36000
2498553	GED9991055S	2 chains each 3 m	10.0	68500
2498545	GED9991056S	2 chains each 3 m	16.0	187000

GED999

TWIST DRILL



Code	No.	↳mm↳	∅	↕
2515504	GED9991060C	100	6	20
2515490	GED9991061C	120	7	30
2515482	GED9991062C	140	8	50
2515474	GED9991063C	160	9	75
2515342	GED9991064C	180	10	100
2515334	GED9991065C	200	11	120
2515326	GED9991066C	220	12	170
2515318	GED9991067C	240	13	220
2515296	GED9991068C	260	14	280
2515261	GED9991069C	280	15	360
2515253	GED9991070C	300	16	440
2515245	GED9991071C	300	17	500
2515237	GED9991072C	320	18	600
2515229	GED9991073C	320	19	700
2515210	GED9991074C	330	20	800

Article Index	
Article	Page
A	
Adjustable spanner	60
Adjustable wrench	60
Angled scraper	77
Angled scraper with handle	77
Angular mandrel	72
Axe	86
B	
Barrel hook	95
Barrel spanner universal	28
Bending bar	94
B-Handwheel spanner	28
Bolt Cutters	63
Bricklayer's chisel	71
Bricklayer's hammer	68
Broad trowel	79
Broom	82
Brush	82, 83
Bucket	99
C	
Caps 25 mm Ø	70
Caps 40 mm Ø	70
Caps 50 mm Ø	70
Caps 65 mm Ø	71
Caps 75 mm Ø	71
Carbide drum opener	95
Centre punch	73
Chain pipe wrench	60
Chisel hammer	69
Circlip pliers for external retaining rings	62
Circlip pliers for internal retaining rings	63
Claw hammer	68
Cleaning tool	79
Club hammer	66, 67
Combination pliers	61
Combination pliers, adjustable	61
Combination pliers, insulated	61
Combination spanner	15
Combination spanner INCH	16
Combination spanner offset	17
Combination spanner set	15
Combination spanner set INCH	16
Combination spanner set, extra long	16
Combination spanner set, offset	17
Combination spanner, extra long	16
Concrete chisel	71
Construction ratchet, hexagonal, with "rat-tail" handle	33
Convertor 1/2" to 3/4"	39
Convertor 1/4" to 1/2"	36
Convertor 3/4" to 1"	42
Convertor for impact sockets 1" to 1.1/2"	49
Convertor for impact sockets 1/2" to 3/4"	46
Convertor for impact sockets 3/4" to 1"	48

Article Index	
Article	Page
Coupler 1"	45
Coupler 1/2"	39
Coupler 1/4"	37
Coupler 3/4"	42
Coupling spanner	26
Crate opener	95
Crimping pliers	63
Cross-cut chisel	71
Crowbar	93, 94
Crowfoot spanner, open-end form, square 1/2"	33
Cup brush	83
Cylinder brush	83
D	
Deep ring spanner	24
Deep ring spanner INCH	24
Deep ring spanner set, 18 pieces	24
Dished scraper	78
Double ended ring spanner offset	17
Double ended ring spanner offset INCH	18
Double ended ring spanner set, offset INCH, 8 pieces	18
Double ended ring spanner set, offset, 12 pieces	17
Double ended ring spanner straight	18
Double ended ring spanner straight INCH	19
Double open ended spanner	12, 14
Double open ended spanner INCH	13, 14
Double open ended spanner set INCH, 8 pieces	13
Double open ended spanner set small, 10 pieces	13
Double open ended spanner set, 12 pieces	12
Double open ended spanner small	13
Drawing knife	103
Drift pin	73
Drift punch	69, 72
Drift punch set	73
Driving handle 1/4"	36
E	
Elbow pipe wrench	60
End cutting nippers	62
Engineers' hammer	66, 67
Extension 1"	44
Extension 1/2"	38
Extension 1/4"	36
Extension 3/4"	42
Extension for impact sockets 1"	49
Extension for impact sockets 1/2"	46
Extension for impact sockets 3/4"	48
Extension tube for deep ring spanners	24
F	
Face pin spanner	27
Filling trowel	79
Firefighter's axe	86
Firefighter's hatchet	86
Fireman's hook	86
Flange knife	93

Article Index	
Article	Page

Flange spreader	102
Flange wedge	92
Flat cold chisel	71
Flat file	99
Flat nose pliers	62
Flat scraper	77
Floor scraper	79
Folding spade	87
Fork for guncotton	89
Forklift	103
Friction ratchet with bi-hexagon ring	33

G

Gas pipe pliers	60
Gib-head key	92

H

Hacksaw	98
Half-round file	99
Hand broom	82
Hand brush	82
Hand hammer	67
Hand pick	86
Hand saw	98
Hand shovel	88
Handwheel spanner	27
Hatchet	86
Hay fork	89
Hearing needle	102
Hearing needle with ballhead	102
Hedge shears	89
Hexagon Allen key	56, 57
Hexagon Allen key set	55
Hexagon Allen key with handle	55
Hexagon Allen key with T-handle	57
Hexagon Allen key with T-handle, long	57
Hexagonal socket spanner	29
Hexagonal socket spanner angled	30
Hexagonal socket spanner double-sided	31
Hexagonal socket wrench with firm sliding bar	31
Hoe	86
Hole/drift punch	68
Hook spanner	27

I

Ideal pattern snips	63
Impact socket 1"	49
Impact socket 1" hexagon	48
Impact socket 1" hexagon, long	49
Impact socket 1.1/2" hexagon	50
Impact socket 1.1/2" hexagon, long	50
Impact socket 1/2"	46
Impact socket 1/2" hexagon	46
Impact socket 1/2" hexagon, long	46
Impact socket 2.1/2" hexagon	51
Impact socket 3/4"	48

Article Index	
Article	Page

Impact socket 3/4" hexagon	47
Impact socket 3/4" hexagon, long	47
Installation open-end spanner with mandrel	25
Installation open-end spanner with mandrel INCH	25
Installation open-end spanner with mandrel INCH, offset	26
Installation open-end spanner with mandrel, offset	25
Installation ring spanner with mandrel INCH, offset	26
Installation ring spanner with mandrel, offset	26

K

Knife	76
-------------	----

L

L-handle 1"	45
L-handle 1/2"	39
L-handle 3/4"	43
Lifting rod	94

M

Machinist's hammer	68
Mallet	68
Manure fork	88
Miner's pick	86
Mining hammer	67
Multipurpose scissors	63

N

Needles	102
Non-sparking holder	70
Nut driver with handle	32
Nut driver with handle INCH	32

O

Open ended slogging spanner	20
Open ended slogging spanner INCH	20
Open ended spanner	22
Open ended spanner INCH	23

P

Parallel vice	99
Pickaxe	87
Pin punch	73
Pin punch set	73
Pincer	62
Pipe cutter	98
Pipe wrench, American pattern	60
Pipe wrench, Swedish pattern	60
Plastic hammer	70
Plastic tweezers	102
Pliers set	63
Pocket vernier calliper	99
Point chisel	71
Pointing trowel	79
Portable, hand-operated oil pump	103
Power side cutter	61
Power side cutter, insulated	61

Article Index
Article Page

Pronged wrench without tommy bar 32
 Protective hand guard 72
 Pulley 103

R

Rake 89
 Ratchet handle with coupler 1" 44
 Ratchet handle with coupler 1/2" 38
 Ratchet handle with coupler 1/4" 36
 Ratchet handle with coupler 3/4" 42
 Recoilless hammer 69, 70
 Reducer 1" to 3/4" 45
 Reducer 1/2" to 1/4" 39
 Reducer 3/4" to 1/2" 42
 Reducer for impact sockets 1" to 3/4" 49
 Reducer for impact sockets 1.1/2" to 1" 50
 Reducer for impact sockets 1/2" to 1/4" 47
 Reducer for impact sockets 2.1/2" to 1.1/2" 51
 Reducer for impact sockets 3/4" to 1/2" 48
 Reversible ratchet 1" 44
 Reversible ratchet 1/2" 38
 Reversible ratchet 1/4" 36
 Reversible ratchet 3/4" 42
 Ring slogging spanner 21
 Ring slogging spanner INCH 21
 Ring slogging spanner offset 22
 Round brush 83
 Round file 99
 Round nose pliers 61
 Rubber mallet 69
 Rust scraper 78

S

Safety pin for impact sockets 1" 49
 Safety pin for impact sockets 1.1/2" 50
 Safety pin for impact sockets 1/2" 47
 Safety pin for impact sockets 2.1/2" 51
 Safety pin for impact sockets 3/4" 48
 Safety ring for hammers 102
 Safety ring for impact sockets 1" 49
 Safety ring for impact sockets 1.1/2" 50
 Safety ring for impact sockets 1/2" 47
 Safety ring for impact sockets 2.1/2" 51
 Safety ring for impact sockets 3/4" 48
 Sawblade for hacksaw 98
 Scaling hammer 68
 Scissors 63
 Scraper 76, 78
 Scraper with handle 78
 Screw clamp 98
 Screw clamp with deep reach 99
 Screwdriver 54
 Screwdriver bit 1/4" 51
 Screwdriver bit socket 1" 45
 Screwdriver bit socket 1/2" 40
 Screwdriver bit socket 1/2", long 41

Article Index
Article Page

Screwdriver bit socket 3/4" 43
 Screwdriver bit socket set 1/2" 41
 Screwdriver sets 54
 Scriber 72
 Scrubber 82
 Set hammer 67
 Setting punch 73
 Sewer lid hook 29
 Sewer lid hook - reinforced type 29
 Shackle 102
 Ship scraper 79
 Shovel 88
 Shovel, Frankfurt pattern 87
 Sickle 89
 Side cutter 61
 Single ended ring spanner straight 19
 Single ended ring spanner straight INCH 19
 Single open ended spanner 14
 Single open ended spanner INCH 15
 Sledge hammer 66
 Slide claw 27
 Sliding T bar 1" 44
 Sliding T bar 1/2" 39
 Sliding T bar 1/4" 36
 Sliding T bar 3/4" 42
 Smoothing trowel 78
 Socket 1" hexagon 44
 Socket 1" hexagon INCH 44
 Socket 1/2" hexagon 37
 Socket 1/2" hexagon INCH 38
 Socket 1/2" hexagon, long 38
 Socket 1/4" hexagon 36
 Socket 3/4" hexagon 41
 Socket 3/4" hexagon INCH 41
 Socket set 1" 45
 Socket set 1/2" 40
 Socket set 1/4" 37
 Socket set 3/4" 43
 Space chisel 92
 Spade 87
 Spade fork 88
 Spanner for tanker valve 28
 Spark plug brush 83
 Spattle 77
 Special all-purpose spanner 29
 Special extender for 1/2" crowfoot spanner 33
 Speed brace 1" 45
 Speed brace 1/2" 39
 Speed brace 3/4" 43
 Splitting chisel 71
 Spray booth scraper 77
 Square bladed awl 72
 Square socket spanner angled 28
 Squeegee 83
 Stone wedge 92
 Stripping pliers 62

Article Index	
Article	Page
Swivel handle 1"	44
Swivel handle 1/2"	38
Swivel handle 1/4"	36
Swivel handle 3/4"	42
Swivel handle with sliding T 1"	45
Swivel handle with sliding T 1/2"	40
Swivel handle with sliding T 3/4"	43
Swivel-head hook spanner	27

T

Taper punch	73
Telephone pliers	62
Telephone pliers, insulated	62
T-handle 1/2"	39
T-handle 3/4"	43
Thread cleaning pin	73
Three-square scraper	77
Tin snips	63
Tommy bar for crowfoot spanners	32
Tommy bar for hexagonal socket spanner	30, 31
Triangular ship scraper	77
Triangular socket spanner	28
Triangular socket spanner set 1/2"	28
Trowel	78
Tweezers edgeless	102
Tweezers pointed	102
Twist drill	103
Twist drill set	103
Tyre lever	94, 95

U

Universal joint 1"	45
Universal joint 1/2"	39
Universal joint 1/4"	37
Universal joint 3/4"	42
Universal joint for impact sockets 1"	49
Universal joint for impact sockets 1/2"	47
Universal joint for impact sockets 3/4"	48
Universal wrench	28

V

Valve hook	27
------------------	----

W

Water pump pliers	61
Wedge	92
Wire brush	82
Wooden mallet	69
Wrecking bar	93

Y

Yarning chisel/yarning tool	76
-----------------------------------	----

Article Index	
Article	Page

Article Index	
Article	Page
108 UNI.....	72
226 E.....	69
227 E.....	69
228.....	69
GED.....	51
GED000.....	89
GED001.....	12
GED0010.....	12, 13, 21, 22
GED0010.....	70
GED0017.....	13
GED00171.....	14
GED00171.....	99
GED00172.....	13
GED00172.....	99
GED0020.....	14
GED0020.....	70
GED0020.....	95
GED0021.....	15
GED003.....	20
GED009.....	19
GED011.....	17, 18
GED012.....	18, 19
GED0130.....	15
GED0137.....	16, 17
GED0137.....	77
GED01373.....	25, 26
GED01374.....	33
GED01375.....	26
GED01376.....	32, 33
GED014.....	57
GED0150.....	28, 29
GED0150.....	88
GED025.....	55, 56, 57
GED0251.....	29, 30
GED027.....	24
GED0300.....	28
GED031.....	22, 23
GED0340.....	30, 31
GED0341.....	28, 32
GED035.....	36, 37, 38, 41, 44
GED035.....	46 – 51
GED0351.....	46 – 49
GED0359.....	28
GED0360.....	36, 38, 42, 44
GED0370.....	39, 43
GED04.....	42
GED0400.....	36 – 40, 42 – 45
GED0410.....	36, 38, 42, 44
GED042.....	38, 44
GED0421.....	36
GED0430.....	37, 40, 43, 45
GED0440.....	40, 41, 43, 45
GED048.....	60
GED050.....	61
GED051.....	60
GED052.....	60

Article Index	
Article	Page
GED053.....	60
GED055.....	60
GED060.....	61
GED061.....	62
GED062.....	61, 63
GED063.....	62
GED064.....	62
GED065.....	60
GED066.....	61
GED068.....	62
GED069.....	63
GED0712.....	63
GED073.....	102
GED073.....	76
GED080.....	54, 55, 57
GED081.....	54
GED081.....	72
GED083.....	57
GED090.....	27
GED091.....	27
GED092.....	95
GED100.....	66
GED102.....	67
GED103.....	66, 67
GED104.....	66
GED105.....	68
GED106.....	68
GED108.....	67
GED109.....	67
GED110.....	98
GED111.....	98
GED112.....	68
GED113.....	67
GED115.....	71
GED116.....	68, 71
GED117.....	73
GED118.....	72, 73
GED119.....	73
GED120.....	72, 73
GED121.....	83
GED125.....	87
GED126.....	87
GED131.....	78, 79
GED132.....	78
GED133.....	78
GED134.....	79
GED135.....	77
GED136.....	73
GED136.....	77
GED138.....	77
GED139.....	76, 78, 79
GED140.....	76
GED145.....	86
GED146.....	86
GED15.....	70
GED151.....	88, 89

Article Index	
Article	Page
GED152.....	87
GED153.....	87
GED156.....	99
GED160.....	61
GED160.....	93, 94
GED161.....	93
GED162.....	73
GED162.....	94
GED163.....	94, 95
GED170.....	99
GED175.....	82, 83
GED176.....	82, 83
GED177.....	83
GED178.....	83
GED179.....	83
GED180.....	98, 99
GED181.....	102
GED185.....	92
GED186.....	102
GED186.....	92
GED190.....	76
GED195.....	72
GED211.....	99
GED25.....	71
GED30.....	71
GED700.....	27
GED701.....	27
GED701.....	68
GED702.....	27
GED702.....	63
GED702.....	68
GED703.....	26, 27
GED703.....	68
GED704.....	69
GED705.....	69
GED708.....	71
GED709.....	71
GED710.....	71
GED711.....	71
GED712.....	92
GED714.....	77
GED715.....	78
GED716.....	86
GED717.....	86
GED718.....	86
GED719.....	86
GED720.....	93
GED721.....	99
GED722.....	60
GED723.....	76, 79
GED724.....	103
GED724.....	95
GED7240.....	29
GED725.....	63
GED771.....	98
GED999.....	102, 103

Article Index	
Article	Page
GED999.....	63
GED999.....	77
GED999.....	98
GED9991.....	28
GEDSDS.....	70
GEDSFN.....	69
GEDSPI.....	70
GEDSPS.....	70
GEDSTPN.....	70

GEDORE Werkzeugfabrik GmbH & Co. KG

Remscheid-Str. 149
42899 Remscheid · GERMANY
Tel. + 49 (0) 21 91- 596 - 0
Fax + 49 (0) 21 91- 596 - 230
info@gedore.com
www.gedore.com
Vertrieb Deutschland
Tel. + 49 (0) 21 91- 596 - 900
Fax + 49 (0) 21 91- 596 - 999
Sales International
Tel. + 49 (0) 21 91- 596 - 910
Fax + 49 (0) 21 91- 596 - 911

GEDORE Automotive GmbH

Breslauer Straße 41
78166 Donaueschingen · GERMANY
Tel. +49 711 83223-0
Fax +49 711 83223-90

GEDORE Torque Solutions GmbH

Bertha-Benz-Straße 12
71665 Vaihingen/Enz · GERMANY
T +49 7042 9441-0
F +49 7042 9441-41
info@loesomat.de

GEDORE AUSTRIA GmbH

Gedore-Str. 1
8190 Birkfeld / Stmk. · AUSTRIA
Tel. +43 (0) 3174 / 363 64 00
Fax +43 (0) 3174 / 363 83 20
sales.austria@gedore.com
www.gedore.at

GEDORE IBÉRICA S.L.

c/Arangutxi 12, Poligono Industrial de Jándiz
01015 Vitoria Alava · SPAIN
Tel. +34-945-29 22 62
Fax +34-945-29 21 99
gedore@gedore.es
www.gedore.es

GEDORE UK Limited

Marton Street , SKIPTON BD23 1TF
North Yorkshire · UNITED KINGDOM
Tel. +44 (0) 1756 / 70 67 00
Fax +44 (0) 1756 / 79 80 83
sales@gedoreuk.com
www.gedoreuk.com

Ferramentas GEDORE do Brasil S.A.

Rua Vicentina Maria Fidélis, 275 Bairro Vicentina | Vicentina
São Leopoldo - RS | 93025-340 · BRAZIL
Tel. +55 51-35 89 9200
Fax + 55 51-35 89 9222
export@gedore.com.br
www.gedore.com.br

GEDORE TECHNAG B.V.

Flemingweg 7, 2408 AV
Alphen aan den Rijn · NETHERLANDS
Tel. +31 (0) 172 / 42 73 50
Fax +31 (0) 172 / 42 73 60
technag@gedore.nl
www.gedore.nl

GEDORE POLSKA Sp. z o.o.

ul. Żwirki i Wigury 56a
43-190 Mikołów · POLAND
Tel. +48 (0) 32 / 738-40 10
Fax +48 (0) 32 / 738-40 20
gedore@gedore.pl
www.gedore.pl

GEDORE TOOLS, INC.

7187 Bryhawke Circle, Suite 700
NORTH CHARLESTON,
SC 29418 · USA
Tel. +1-843/225 50 15
Fax +1-843/225 50 20
info@gedoretools.com
www.gedoretools.com

GEDORE France SARL

Parc d'activités des Béthunes - La Mare II
10, avenue du Fief - Bât. 12
BP 79144 Saint-Ouen-l'Aumône
F-95074 Cergy Pontoise Cedex · FRANCE
Tél. +33 (0)1 34 40 16 60
Fax +33 (0)1 34 40 16 61
jadore@gedore.fr
www.gedore.fr

GEDORE Tool Trading (Shanghai) Co., Ltd.

1/F., Block 2, 1358 Pingan Road,
Minhang, Shanghai · CHINA 201109
Tel. +86-21-3388 7258
Fax +86-21-3388 7259
Service Hotline: 400 880 1858
info@gedore.cn
www.gedore.cn

GEDORE Tools S.A. (Pty) Ltd.

103 Qashana Khuzwayo (Shepstone) Road,
New Germany, 3610 - South Africa
PO Box 68, New Germany, 3620
SOUTH AFRICA
Tel. +27 (0) 31 / 705 3587
Fax +27 (0) 31 / 705 32770
general@gedoresa.co.za
www.gedore.co.za

GEDORE (INDIA) Private Limited

148, Sector 3, IMT Manesar
Gurgaon – 122051
Haryana · INDIA
Tel. +91 (0) 124 22910 – 65/66/67
Fax +91 124 2341067
sales@gedoreindia.com
www.gedore.in

GEDORE TOOLS MIDDLE EAST FZE

P.O Box 372042
West Wing 5B, Office #440
Dubai Airport Free Zone
Dubai · U.A.E
Tel. +971 4 236 4606
info@gedore.ae

GEDORE TOOL CENTER OOO

4.-ya Magistralnaja H11/1
123007 Moscow · RUSSIA
Tel. 8 800 100 58 96 (free from Russia)
Tel. +7 (499) 754 7000
Fax +7 (8) 985 22 99 88 0
sales@gedoretools.ru

Disclaimer

This catalogue replaces all previous editions.
The photographs and technical details are of the articles offered at present.

Since we are constantly updating and improving our products to keep them at the present state of the art, we reserve the right to make modifications and changes with regard to appearance, dimensions (always in "mm", if not otherwise stated), weights and properties, as well as in performance. No claim for correction or replacement supplies may thus be made with regard to products already delivered.

Cancellations may be made at any time without there being any grounds for legal claim.
All information on use or safety is non-binding; nor does it replace any legal regulations or those made by professional or trade associations.

We do not accept any liability for printing errors. No supplemental items (tools etc.) are included in the scope of supply.

Reprinting, even of excerpts, requires the previous permission in writing by GEDORE.
All rights reserved worldwide.

We refer to our current general agreements and commercial conditions as well as our delivery and payment conditions in the imprint under www.gedore.com

GEDORE Werkzeugfabrik GmbH & Co. KG

Remscheider Straße 149
42899 Remscheid · GERMANY
Tel. + 49 (0) 21 91- 596 - 0
Fax + 49 (0) 21 91- 596 - 230
Amtsgericht Wuppertal, HRA 17944

Overall concept, design and layout:
GEDORE Werkzeugfabrik GmbH & Co. KG, Remscheid

© Copyright by GEDORE

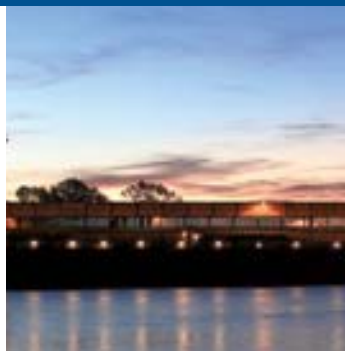

GEDORE Werkzeugfabrik GmbH & Co. KG

Remscheider Straße 149
42899 Remscheid · GERMANY
Postfach 120361 · 42873 Remscheid

Fon + 49 21 91 596-0
Fax + 49 21 91 596-230
info@gedore.com · www.gedore.com

Sales GERMANY
Fon + 49 21 91 596-900 · Fax + 49 21 91 596-999
Sales INTERNATIONAL
Fon + 49 21 91 596-910 · Fax + 49 21 91 596-911

www.gedore.com

Amtsgericht Wuppertal, HRA 17944